



UNIVERSIDAD DE CONCEPCIÓN  
FACULTAD DE CIENCIAS NATURALES Y OCEANOGRÁFICAS  
Doctorado en Ciencias Biológicas, Área Botánica

**Efecto de condiciones foto-autotróficas en cultivares de *Stevia Rebaudiana* B.  
sobre la producción de esteviol glicósidos**

Tesis para optar al grado de Doctor en Ciencias Biológicas, Área Botánica



**KAREL ALBERTO VIVES HERNANDEZ**

Profesor Guía: Dra. Claudia Pérez Manríquez

Profesor Co-guía: Dra. Darcy Ríos Leal

Concepción, Chile 2021



© 2021

Karel Alberto Vives Hernández

Se autoriza la reproducción total o parcial, con fines académicos, por cualquier medio o procedimiento, incluyendo la cita bibliográfica del documento.

**Efecto de condiciones foto-autotróficas en cultivares de *Stevia Rebaudiana* B.  
sobre la producción de esteviol glicósidos**

Esta Tesis fue desarrollada en el Laboratorio de Química de Productos Naturales, Departamento de Botánica, Facultad de Ciencias Naturales y Oceanográficas y el Laboratorio de Cultivo de Tejidos Vegetales, Centro de Biotecnología, Facultad de Ciencias Forestales, Universidad de Concepción.

Profesor Guía

---

**Dra. Claudia Pérez Manríquez**  
Profesora Asociada  
Ciencias Químicas

Profesor Co- Guía

---

**Dra. Darcy Ríos Leal**  
Profesora Titular  
Biología

**COMISIÓN EVALUADORA**



**Dr. Eduardo Alfonso Ruiz Ponce**

Facultad de Ciencias Naturales y Oceanográficas  
Universidad de Concepción

---

**Dr. José Becerra Allende**

Facultad de Ciencias Naturales y Oceanográficas  
Universidad de Concepción

---

**Dr. Daniel Durán Sandoval**

Facultad de Farmacia  
Universidad de Concepción

---

**Dr. Pablo Pablo César Guerrero Martin**

Director Programa Doctorado en Cs. Biológicas, Área  
Botánica, Facultad de Ciencias Naturales y Oceanográficas,  
Universidad de Concepción

---



## DEDICATORIA

*A mi papá, mi mamá y mi esposa,*

*"Papá: nos quisiste con tanta fuerza y bondad que tu amor siempre estará grabado en nuestra alma"...*

*Por y para ustedes; ¡los amo!*

## AGRADECIMIENTOS

*Al profesor Becerra, por su apoyo incondicional, por cada uno de sus consejos llenos de sabiduría y por su cariño.*

*A mis tutoras, Claudia y Darcy por aceptarme y ser una fuente inagotable de apoyo y enseñanzas.*

*Al Laboratorio de Fitoquímica de la Facultad de Ciencia Naturales y Oceanográficas, por aceptarme en el grupo y brindarme conocimientos prácticos.*

*Al Laboratorio de Cultivo de Tejidos Vegetales del Centro de Biotecnología, por permitirme ser parte del grupo y por los momentos de alegría compartidos.*

*Al profesor Pablo Guerrero, por todo el apoyo y el ánimo constante durante el trayecto.*

*Al profesor Jaime Martínez, por abrirme las puertas de su grupo "Regulación por Luz y Sombra del Desarrollo Vegetal" CRAG-UAB, España y permitir que me apoderara de un abanico de nuevos conocimientos.*

*A Jordi Moreno, por tu amistad, tu apoyo, por las inagotables horas de trabajo compartidas y por la total entrega de tu experiencia científica: ¡GRACIAS!*

*A mi Mercè, por tu cariño incondicional a mí y a mi tierra, por compartir tantos cafés y puntos en común, por los oasis; ¡Visca Catalunya independent!*

*A mis hermanos Wenting y Sandi, por ser mis acompañantes en esta travesía del doctorado, por los buenos momentos compartidos y los que faltan, ¡mi cariño eterno!*

*A Isa, mi Asturiana preferida, amiga, compañera de piso y paño de lágrimas en muchas ocasiones: gracias, ¡Ya esquiaremos en los Alpes Suizos!*

*A mi hermano del alma, Carlos Aragón, por tu apoyo sin medida, por brindarme la fuerza en tiempos delicados a pesar de la distancia geográfica, has sido mi mentor y un ejemplo al que siempre admiraré, con todo mi cariño, ¡Gracias!*

*A Daviel y Maray, mi otra familia cubana, puesta por el destino para acompañarme en esta aventura y, espero que en muchas otras: ¡gracias por ser ramas del árbol de mi vida!*

*A Inelvis Castro, por la compañía y sus constates palabras de aliento.*

*Al profesor Peña y Libeth, por su cariño y comprensión en momentos difíciles, sin duda otra familia chilena que tendré por siempre en mi corazón.*

*A la Sra. Gloria (La mae), a Coté mi hermana adoptiva y a Claudita por aceptarme y abrirme las puertas de su corazón, ¡eternamente GRACIAS!*

*A cada uno de mis profesores de posgrado que me aportaron su apoyo y sabiduría.*

*A la Beca ANID, que me brindó los medios para llevar a cabo mi investigación durante este tiempo.*

*A mi familia, Tita, tía Maira, tío Willy, Suyi, Rodo, cada uno de ustedes han sido piedra angular, ayudándome a convertirme en la persona que soy*

*A mi tía Ampa, por tu amor incondicional, tu eterna sabiduría y enseñanzas: ¡te adoro!*

*A mis padres Saro y Martha que dieron lo mejor de sí, convirtiendo la familia en amor eterno.*

*A mi esposa Jenny, por tu amor, lealtad y total entrega, por decidirse a acompañar a un Quijote en sus travesías, ¡te estaré eternamente agradecido!*

*Finalmente, a mi Padre Saro Vives, mi abuela Mercedes de la Torre, y mi suegro Manuel Berenguer, por el tiempo que estuvieron a mi lado, ahora sé que me cuidan desde otro espacio, siempre los llevaré bien cerquita (en mi corazón), ¡les envío mi abrazo hasta el cielo!*

*A todos: ¡GRACIAS!*

## TABLA DE CONTENIDO

DEDICATORIA .....	iv
AGRADECIMIENTOS.....	v
TABLA DE CONTENIDO.....	vi
ÍNDICE DE TABLAS.....	ix
ÍNDICE DE ILUSTRACIONES.....	x
RESUMEN GENERAL.....	xiii
<b>I. INTRODUCCIÓN .....</b>	<b>1</b>
I.1. Descripción botánica y distribución geográfica de <i>S. rebaudiana</i> .....	2
I.2. Composición química de <i>Stevia rebaudiana</i> (Bertoni) Bertoni (Asteraceae).....	4
I.3. Síntesis de esteviol glicósidos (SGs) .....	7
I.4. Propagación de <i>S. rebaudiana</i> .....	12
I.4.1. Cultivo <i>in vitro</i> de <i>S. rebaudiana</i> .....	13
Hipótesis.....	19
Objetivo general .....	19
Objetivos específicos .....	19
<b>II. CAPÍTULO I. Effect of light intensity on steviol glycosides production in leaves of <i>Stevia rebaudiana</i> plants.....</b>	<b>20</b>
Abstract .....	22
1. Introduction.....	23
2. Results .....	26
2.1. Comparison of SGs production in Morita II and Criolla cultivars of <i>S. rebaudiana</i> .....	26
2.2. Comparison of the gene expression of key enzymes of the SGs synthesis pathway in Morita II and Criolla cultivars of <i>S. rebaudiana</i> .....	27
2.3. Effect of different light intensities on photosynthetic parameters.....	28
2.4. Effect of light intensity on SGs production in <i>S. rebaudiana</i> cultivar Morita II .....	31
2.5. Effect of light intensity on gene expression levels of <i>SrKA13H</i> , <i>SrUGT74G1</i> and <i>SrUGT76G1</i> in <i>S. rebaudiana</i> cultivar Morita II.....	31
3. Discussion .....	33
3.1. Effect of the expression of SGs biosynthetic genes on the levels of SGs in <i>S. rebaudiana</i> cultivars Morita II and Criolla.....	33
3.2. Effect of light intensity on SGs production in <i>S. rebaudiana</i> .....	35
3.3. Concluding remarks .....	37

4. Experimental .....	38
4.1. Growth conditions to compare <i>S. rebaudiana</i> cultivars Morita II and Criolla .....	38
4.2. Growth conditions at different light intensities of <i>Stevia rebaudiana</i> plants.....	38
4.3. SGs analysis by HPLC .....	38
4.4. Gene expression analysis by RT-qPCR .....	40
4.5. Photosynthetic activity.....	40
4.6. Statistical analysis .....	41
References .....	42
<b>III. CAPÍTULO II. Physiological and metabolic changes associated to the <i>in vitro</i> - <i>ex vitro</i> transition in <i>Stevia rebaudiana</i> cv. Morita II.....</b>	<b>51</b>
Abstract .....	53
1. Introduction.....	54
2. Materials and methods.....	56
Biological material and growth conditions.....	56
2.1. <i>In vitro</i> establishment of <i>S. rebaudiana</i> shoots.....	56
2.2. <i>In vitro</i> multiplication of <i>S. rebaudiana</i> shoots .....	57
2.3. <i>In vitro</i> rooting of <i>S. rebaudiana</i> .....	57
2.4. Acclimatization of <i>S. rebaudiana</i> cv Morita II .....	57
2.5. Physiological evaluations .....	58
2.6. SGs analysis of <i>S. rebaudiana</i> plants cv Morita II .....	59
2.7. SGs analysis by HPLC .....	59
2.8. Gene expression analysis by RT-qPCR .....	60
2.9. Statistical analysis .....	61
3. Results .....	61
3.1. <i>In vitro</i> establishment of <i>S. rebaudiana</i> shoots cv Morita II .....	61
3.2. <i>In vitro</i> multiplication of <i>S. rebaudiana</i> shoots .....	62
3.3. <i>In vitro</i> rooting of <i>S. rebaudiana</i> shoots .....	64
3.4. Effect of different substrates on plant survival and physiological indicators during acclimatization of <i>S. rebaudiana</i> cv. Morita II .....	66
3.5. Characterization of <i>S. rebaudiana</i> cv: Morita II according to SGs production and relative gene expression .....	68
4. Discussion .....	70
4.1 Effect of concentrations of (NaClO) and exposure time on the survival percentage of shoots of <i>S. rebaudiana</i> cv: Morita II .....	70

4.2. Effect of concentrations of BAP during <i>in vitro</i> multiplication of <i>S. rebaudiana</i> shoots .....	71
4.3. Effect of IAA and IBA concentrations during <i>in vitro</i> rooting of <i>S. rebaudiana</i> shoots .....	72
4.4. Effect of different substrates on plant survival and physiological indicators during acclimatization of <i>S. rebaudiana</i> cv. Morita II .....	72
4.5. Characterization of <i>S. rebaudiana</i> cv: Morita II cultivars according to SGs production and relative gene expression .....	73
5. Conclusions .....	77
References .....	78
<b>IV. CAPÍTULO III. Comparison of different <i>in vitro</i> micropropagation methods of <i>Stevia rebaudiana</i> B. including temporary immersion bioreactor (BIT<sup>®</sup>) .....</b>	<b>87</b>
Abstract .....	88
Introduction .....	88
Material and Methods .....	90
Stevioside and rebaudioside analysis A cuantification by HPLC .....	91
Statistical analysis .....	91
Result and Discussion .....	91
Conclusions .....	95
References .....	96
<b>V. DISCUSIÓN GENERAL .....</b>	<b>99</b>
<b>VI. CONCLUSIONES GENERALES .....</b>	<b>106</b>
<b>VII. REFERENCIAS GENERALES .....</b>	<b>107</b>



## ÍNDICE DE TABLAS

<b>Table. II.1.</b> List of primers used for real-time PCR amplification, indicating the resulting amplicon size and primer efficiency ( $E = 10^{(-1/\text{slope})}$ ).....	40
<b>Table. III.1.</b> List of primers used for real-time PCR amplification and the resulting product size.....	61
<b>Table III.2.</b> Effect of BAP concentrations during the multiplication phase on <i>S. rebaudiana</i> plants cv: Morita II.....	63
<b>Table. III.3.</b> Effect of different concentrations and type of auxin during the rooting phase on <i>S. rebaudiana</i> plants cv: Morita II.....	64
<b>Table. III.4.</b> Effect of different types of substrates on the survival rate (%) of <i>S. rebaudiana</i> cv: Morita II plants in the acclimatization phase at 10, 20 and 30 days.....	66
<b>Table. III.5.</b> Effect of different types of substrates on morphological quality indicators in <i>S. rebaudiana</i> cv: Morita II plants 30 days after acclimatization.....	67
<b>Table. III.6.</b> Effect of the different types of substrates on the physiological indicators: relative growth rate (RGR) and net assimilation rate (NAR) of <i>S. rebaudiana</i> cv: Morita II plants 30 days after acclimatization.....	67
<b>Table. IV.1.</b> Effects of culture methods on multiplication and contents of steviol glycosides at 21 days of culture.....	91



## ÍNDICE DE ILUSTRACIONES

- Fig. 1.** Apariencia morfológica típica de órganos en *S. rebaudiana*, (a) hojas en posición opuesta y alternas, (b) tricomas glandulares, (c) semilla tipo aquenio color café claro (infértil), (d) semilla tipo aquenio color café oscuro (fértil), (e) flor blanca hermafrodita.....3
- Fig. 2.** Distribución mundial de la planta de *S. rebaudiana* tomado de Gantait et al., (2018).....4
- Fig. 3.** Estructura química de algunos glucósidos de esteviol. Glc, Rha y Xyl representan restos de monosacáridos de glucosa, ramnosa y xilosa, respectivamente. Tabla tomada de Libik-Konieczny et al., (2021).....5
- Fig. 4.** Descripción esquemática de la vía metabólica para la síntesis de glucósidos de esteviol (SGs) y su organización subcelular en *S. rebaudiana*.....8
- Fig. 5.** Ciclo de funcionamiento de los Biorreactore de Inmersión Temporal (BIT®).....16
- Fig. II.1.** Schematic overview of the metabolic pathway for steviol glycosides (SGs) synthesis and its subcellular organization in *S. rebaudiana*.....25
- Fig. II.2.** Levels of stevioside and rebaudioside A in extracts of leaves from *S. rebaudiana* cultivars Morita II and Criolla. Representative HPLC chromatograms (intensity of absorbance in milli-Absorbance Units - mAU) for the cultivar (A) Morita II and (B) Criolla. Contents of stevioside and rebaudioside A ( $\mu\text{g}\cdot\text{mg}^{-1}$  of dry weight) on leaves of cultivar (C) Morita II and (D) Criolla, grown for 45 days under greenhouse conditions with a light intensity of  $900 \mu\text{mol}\cdot\text{m}^{-2}\cdot\text{s}^{-1}$ . Results with the same letter are not statistically different (One Way ANOVA, Tukey,  $P<0.05$ ,  $n=5$ ).....27
- Fig. II.3.** Relative expression levels of the main genes regulating the metabolic pathway for the synthesis of stevioside and rebaudioside A, *SrKA13H*, *SrUGT74G1* and *SrUGT76G1*, in the *S. rebaudiana* cultivars Morita II and Criolla. Transcription levels were normalized against two reference genes. The mean is represented by an x. The different letter above each box plot indicates significant differences (One Way ANOVA, Tukey,  $P<0.05$ ,  $n=8$ ).....28
- Fig. II.4.** Photosynthetic parameters in *S. rebaudiana* plants cultivar Morita II treated with different light intensities. (A) Morphological appearance of plants 15 days after being subjected to three light intensities: (left) low light ( $80 \mu\text{mol}\cdot\text{m}^{-2}\cdot\text{s}^{-1}$ ), (center) medium light ( $300 \mu\text{mol}\cdot\text{m}^{-2}\cdot\text{s}^{-1}$ ) and (right) high light intensity ( $900 \mu\text{mol}\cdot\text{m}^{-2}\cdot\text{s}^{-1}$ ). (B) Typical measurement obtained from the IMAGIM-PAM chlorophyll fluorometer. (left) Representation of Quantum yield of photochemical energy conversion in PS II (Y(II)) and Pulse-Amplitude-Modulation (PAM) values during the time of the experiment. Different phases has been highlighted: I, initial pulse of actinic light; II, increased steps of actinic light; III, maximum saturation point; IV, recovery after exposure; (right) images of the plants during the different phases of the measurements. (C) Maximum quantum yield of PSII ( $F_v/F_m$ ), (D) Electron transport rate (ETR) and (E) Apparent rate of photosynthesis (PS) obtained at the different light intensities. The error bars represent the standard deviation of the mean ( $n=5$ ). Different letters above each bar indicate significant differences (One Way ANOVA, Tukey,  $P < 0.05$ ).....30
- Fig. II.5.** Effect of three light intensities on the production of stevioside and rebaudioside A and the expression of their biosynthetic enzymes in *S. rebaudiana* cultivar Morita II. Quantification of (A) stevioside and (B) rebaudioside A. Each bar represents the mean. The error bars represent the standard deviation of the mean. Different letters above each bar indicate significant differences (One Way ANOVA, Tukey,  $P < 0.05$ ,  $n=5$ ). Gene expression levels of (C) *SrKA13H*, (D) *SrUGT74G1* (E) and *SrUGT76G1*. Transcription levels were normalized against two reference genes. The mean is represented by an x. The different letter above each box plot indicates significant differences (One Way ANOVA, Tukey,  $P<0.05$ ,  $n=8$ ). (F) Sum of stevioside and rebaudioside A (data from A and B) and ratio of rebaudioside A:stevioside (on the top).....32

- Fig. II.6.** Chromatograms of stevioside and rebaudioside A standard solutions used for the quantification of *S. rebaudiana* leaves extracts. Intensity of absorbance in milli-Absorbance Units (mAU).....39
- Fig. III.1.** Chromatograms of steviosides standards solutions (stevioside and rebaudioside A) used for the quantification of *S. rebaudiana* leaves extracts. Intensity of absorbance in milli-Absorbance Units (mAU).....59
- Fig. III.2.** Effect of exposure time at three concentrations of sodium hypochlorite (NaClO) on the survival percentage of *S. rebaudiana* cv. Morita II explants. Means with unequal letters represent statistically significant differences ( $p \leq 0.05$ ) (one factor ANOVA, Tukey) ( $n = 15$ ). For the statistical treatment the data were transformed according to  $y' = 2 \cdot \arcsin (X/100)^{1/2}$ . Data represent the mean of 15 internodes per treatment.....62
- Fig. III.3.** Morphological appearance of *S. rebaudiana* plants cv. Morita II 21 days after being subjected to different BAP concentrations (0; 1.1; 2.2; 3.3 and 4.4  $\mu\text{mol}\cdot\text{L}^{-1}$ ).....63
- Fig. III.4. (A)** Comparison of the effect IAA and IBA auxin concentrations on the rooting percentage of *S. rebaudiana* cv: Morita II. Means with unequal letters have statistically significant differences (bifactorial ANOVA, Tukey,  $p \leq 0.05$   $n = 35$ ). The data were transformed according to  $y' = \arcsin (X + 0.5) \frac{1}{2}$ . General mean = 62.98%. Standard error of the mean = 7.22%. Morphological appearance of *S. rebaudiana* cv. Morita II 21 days after being subjected to four concentrations of auxins **(B)** IAA (0, 2.46, 4.92, 7.38 and 9.84  $\mu\text{mol}\cdot\text{L}^{-1}$ ) and **(C)** IBA (0, 2.46, 4.92, 7.38 and 9.84  $\mu\text{mol}\cdot\text{L}^{-1}$ ).65
- Fig. III.5** Effect of different substrate mixtures on the leaf area of *S. rebaudiana* cv: Morita II plants grown for 30 days in acclimatization. Medias con letras desiguales tienen diferencias estadísticamente significativas (ANOVA, Tukey,  $p \leq 0,05$ ,  $n = 10$ ).....68
- Fig. III.6.** Comparison of the content of stevioside and rebaudioside A ( $\mu\text{g}\cdot\text{mg}^{-1}$  of dry weight) between *S. rebaudiana* plants grown *ex vitro* for 30 days after being acclimatized and *in vitro* plants from the rooting phase. The results with the same letter are not statistically different (one-way ANOVA, Tukey,  $P > 0.05$ ) \*  $n = 8$ .69
- Fig. III.7.** Comparison of the relative expression of the main genes that regulate the metabolic pathway for the synthesis of stevioside and rebaudioside A among *Stevia rebaudiana* cv. Morita II plants, grown *in vitro* in the rooting phase with plants acclimatized in the mixture of peat and zeolite substrate grown for 30 days. Transcription levels were normalized against reference genes. Each bar represents the mean. Error bars represent the standard deviation of the mean ( $n=8$ ). The different letter above each bar indicates significant differences (Tukey-Kramer method,  $P < 0.05$ ).....70
- Fig. IV.1** Design of plant culture methods and typical phenotype of shoots produced. Glass size container used for micropropagation (1000 ml) and 250 ml culture medium volume (12.5 ml medium/explant) for each culture method assayed. Nodal segments number 20 explants. **a** Micropropagation on semisolid medium. **b** Micropropagation in liquid medium, with shoots maintained on filter paper supports. **c** Operating cycle of BIT<sup>®</sup>. (1) non-immersed stage, shoots were free-standing on the bottom of the culture vessel. (2) Beginning of the immersed stage; an overpressure was applied, and the medium was pushed up into the plant container, immersing the shoots for 3 min. (3) End of the immersed stage, a second solenoid valve was opened and the culture medium was removed into the reservoir. These steps were performed every 6 h. The air pump and electric valves were under control of a timer (Escalona et al. 1999, 2003).....92

**Fig. IV.2** Levels of stevioside and rebaudioside A in extracts of leaves from *S. rebaudiana* cultivar Morita II ( $\text{mg}\cdot\text{mg}^{-1}$  of dry weight), Grown for 21 days under three different propagation methods (BIT; Semisolid medium and Liquid Medium). Results with the same letter are not statistically different (One Way ANOVA, Tukey,  $P < 0.05$ ,  $n = 5$ ).....93

**Fig IV.3.** Typical phenotype of *S. rebaudiana* shoots grown for 21 days under three different propagation methods (BIT; Semisolid medium and Liquid Medium).....94



## RESUMEN GENERAL

*Stevia rebaudiana* (Bertoni) Bertoni (Asteraceae) se considera una especie única debido a la producción en sus hojas de metabolitos especializados; diterpenos del tipo esteviol glicósidos, que le confieren múltiples usos, no sólo en el mercado de edulcorantes, sino también en la agricultura, la ganadería, la industria farmacéutica y la cosmetología. En el mundo existe una gran expectativa sobre su cultivo y es considerada una planta ideal para estudiar patrones de glicosilación de estos metabolitos. A pesar de los múltiples estudios que se realizan en esta especie, las enzimas involucradas en la síntesis de esteviol glicósidos y sus mecanismos de regulación *in vivo*, no han sido totalmente descritos. El manejo adecuado de factores genéticos y ambientales puede provocar cambios favorables para la acumulación de diterpenos glicosilados. Con el objetivo de demostrar que las condiciones foto-autotróficas generan cambios morfológicos favorables para la síntesis de esteviol glicósidos en *S. rebaudiana*, en comparación con los métodos de micropropagación convencional; se estudiaron los contenidos de steviosido y rebaudiosido A y la expresión génica de *SrKA13H*, *SrUGT74G1* y *SrUGT76G1* para los cultivares Morita II y Criolla. Los mayores niveles de expresión de los genes estudiados se registraron para el cultivar Morita II. La producción de rebaudiosido A fue 9,69 veces mayor en el cultivar Morita II, que acumuló 3,4 veces menos esteviósido, que el cultivar Criolla. Cuando el cultivar Morita II creció bajo diferentes intensidades de luz, los niveles de transcripción de los genes *SrKA13H*, *SrUGT74G1* y *SrUGT76G1* aumentaron a mayores intensidades lumínicas, favoreciendo la producción de esteviol glicósidos. Se encontró que la mezcla de sustratos turba más zeolita favoreció todos los parámetros fisiológicos estudiados, así como la mayor producción de esteviósido y rebaudiosido A, importantes para la industria alimentaria y farmacéutica. Durante la transición de condiciones mixo-tróficas (enraizamiento *in vitro*) a condiciones foto-autotróficas (aclimatación *ex vitro*), los niveles de transcripción génica de *SrKA13H*, *SrUGT74G1* y *SrUGT76G1* y la producción de diterpenos glicosilados aumentaron significativamente en plantas de *S. rebaudiana* (cv. Morita II). Comparamos tres métodos de cultivo medio semisólido, medio líquido y biorreactores de inmersión temporal en términos de biomasa y producción de glicósidos de esteviol. Se observó mayores indicadores de calidad morfológica de brotes cultivados en biorreactores de inmersión temporal con respecto a los otros métodos de cultivo. A su vez, se registró mayor contenido de glicósidos de esteviol total en las plantas crecidas en biorreactores de inmersión temporal, demostrándose que este sistema de cultivo *in vitro* es un método eficiente para la obtención de metabolitos especializados con alto poder edulcorante como el rebaudiosido A y el esteviósido.

## GENERAL ABSTRACT

*Stevia rebaudiana* (Bertoni) Bertoni (Asteraceae) is considered a unique species due to the production in its leaves of specialized metabolites; diterpenes of the steviol glycosides type, which give it multiple uses, not only in the sweetener market, but also in agriculture, livestock, the pharmaceutical industry, and cosmetology. In the world there is great expectation about its cultivation, and it is considered an ideal plant to study glycosylation patterns of these metabolites. Despite the multiple studies carried out in this species, the enzymes involved in the synthesis of steviol glycosides, and their regulation mechanisms *in vivo* have not been fully described. Proper management of genetic and environmental factors can cause favorable changes for the accumulation of these glycosylated diterpenes. In order to demonstrate that photo-autotrophic conditions generate favorable morphological changes for the synthesis of SGs in *S. rebaudiana*, in comparison with conventional micropropagation methods; the contents of stevioside and rebaudioside A and the gene expression of *SrKA13H*, *SrUGT74G1* and *SrUGT76G1* were studied for the Morita II and Criolla cultivars. The highest levels of expression of the genes studied were recorded for the Morita II cultivar. The production of rebaudioside A was 9.69 times higher in the Morita II cultivar, which accumulated 3.4 times less stevioside than the Criolla cultivar. When the Morita II cultivar was grown under different light intensities, the transcription levels of the *SrKA13H*, *SrUGT74G1* and *SrUGT76G1* genes increased at higher light intensities, favoring the production of steviol glycosides. It was found that the mixture of peat and zeolite substrates favored all the studied physiological parameters, as well as the higher production of steviosides and rebaudioside A, important for the food and pharmaceutical industry. During the transition from myxo-trophic conditions (*in vitro* rooting) to photo-autotrophic conditions (*ex vitro* acclimation), the gene transcription levels of *SrKA13H*, *SrUGT74G1* and *SrUGT76G1* and the production of glycosylated diterpenes increased significantly in *S. rebaudiana* plants (cv. Morita II). We compared three culture methods semi-solid medium, liquid medium, and temporary immersion bioreactors in terms of biomass and steviol glycoside production. Higher indicators of morphological quality of shoots grown in temporary immersion bioreactors were observed with respect to other culture methods. In turn, a higher content of total steviol glycosides was recorded in plants grown in temporary immersion bioreactors, proving this *in vitro* culture system to be an efficient method for obtaining specialized metabolites with high sweetening power such as rebaudioside A and stevioside.

## I. INTRODUCCIÓN

La naturaleza se considera maestra artesana, creadora de inagotables entidades moleculares. Las plantas, en su interacción con el ambiente, son capaces de sintetizar cientos de compuestos, que se consideran principios activos de medicamentos, insecticidas, herbicidas, colorantes alimentarios y saborizantes naturales (Patil et al., 2021). Los productos naturales han sido la columna vertebral de la tradición curativa desde tiempos remotos; pero su aplicación, como compuestos aislados y caracterizados, comenzó a partir del siglo XIX (Erb y Kliebenstein, 2020). La selección de plantas para estos propósitos debe contemplar aspectos como: fácil cultivo, alto contenido de principios activos potentes, alta estabilidad química y óptima producción (Agarwal et al., 2020).

Los recursos genéticos de las plantas cultivadas constituyen la base biológica de la seguridad alimentaria mundial, al ser fundamentales para una producción agrícola sostenible. La conservación, utilización y distribución justa y equitativa de los beneficios derivados de su uso, son objeto de preocupación internacional (Wambugu et al., 2018; Smyth et al., 2020). Existen plantas ricas en productos naturales, cuya explotación puede ocasionar cambios en los ecosistemas. La protección de especies vegetales es un aspecto para considerar cuando se seleccionan plantas para obtener metabolitos secundarios de interés comercial (Jain et al., 2019; D'Amelia et al., 2021). El cultivo de tejidos es uno de los principales componentes de la Biotecnología Vegetal y se define como la ciencia del crecimiento de las células, los tejidos y órganos de las plantas, separados de la planta madre, en un medio artificial (Hussain et al., 2012; Bridgen et al., 2018; Lone et al., 2020).

*Stevia rebaudiana* (Bertoni) Bertoni es una planta arbustiva perenne que pertenece a la familia Asteraceae. Originaria de América del Sur, actualmente se cultiva en muchas regiones del mundo, incluidas Asia, Europa y América del Norte (Singh et al., 2015; Khiraoui et al., 2017; Ahmad et al., 2020). Existen más de 200 especies de *Stevia* dispersas a nivel mundial, sin embargo *S. rebaudiana* se ha convertido en la más famosa, debido al alto potencial edulcorante de metabolitos especializados nombrados esteviol glicósidos (SGs) sintetizados en sus hojas con un poder edulzante 200-400 veces mayor al de la sacarosa (Goyal et al. 2010; Harismah et al., 2018; Jahangir

et al., 2020). Además de *S. rebaudiana*, se han encontrado glicósidos de esteviol en otras tres especies: *Stevia phlebophylla*, (Kinghorn et al., 1984) *Rubus suavissimus* (Tanaka et al., 1981) y *Angelica keiskei* (Zhou et al., 2012).

### **I.1. Descripción botánica y distribución geográfica de *S. rebaudiana***

*Stevia rebaudiana* (Bertoni) Bertoni (Asteraceae), es una planta herbácea que crece hasta 30 cm de altura y requiere para su crecimiento, temperaturas cálidas, precipitaciones adecuadas y altas intensidades lumínicas (Gantait et al., 2018). Es considerada una planta perenne que habitualmente crece en climas tropicales y subtropicales, generalmente se cultiva como planta anual en climas más fríos (Parris et al., 2016). Durante siglos, los pueblos indígenas guaraníes de Paraguay masticaban las hojas para percibir su sabor dulce, las secaban y las usaban como edulcorante natural para endulzar el mate y otras infusiones, o las empleaban en la medicina tradicional (Cosson et al., 2019).

Tiene hojas pequeñas, sésiles, en disposición alterna y forma lanceolada. El margen de la hoja está aserrado y pueden variar ampliamente debido a muchos factores ambientales, incluidas las condiciones del suelo, métodos de riego, luz solar, pureza del aire, manejo agronómico, afectando también las proporciones de dulzor y amargor en sus hojas (Alamgir, 2017; Shahnawaz et al., 2021). En hojas pubescentes presentan tricomas glandulares que por lo general son estructuras secretoras desarrolladas en la superficie de todos los órganos, tanto vegetativos como reproductivos (Werker, 2000). Surgen de las células protodermales como un resultado de una serie de divisiones anticlinal y periclinal (Castro y Demarco, 2008). las estructuras secretoras son pelos glandulares (tricomas glandulares) (Cornara et al., 2006; De Vargas et al., 2019). Estos tricomas en *S. rebaudiana* se encuentran hundidos en surcos en la epidermis de la hoja, principalmente presentan distintos tamaños grandes (4-5  $\mu\text{m}$ ) y pequeños (2,5  $\mu\text{m}$ ) (Monteiro et al., 2001).

La planta es auto incompatible, el tipo de polinización es entomófila. La semilla es un aquenio de aproximadamente 3 mm, que puede ser claro (estéril) u oscuro (fértil) y es diseminado por el viento. Es diploide, con 11 pares de cromosomas, característica típica de la mayoría de los miembros del género *Stevia* (Yadav et al., 2011). Las semillas son muy pequeñas (1000 semillas pesan de 0,3 a



1,0 g) y, como resultado, las plántulas tardan en desarrollarse, alcanzando un tamaño adecuado para trasplantarlas al campo a los 45-60 días. Se ha reportado que es necesaria cierta manipulación activa de las flores para lograr la polinización. Se han registrado rendimientos de semilla de hasta 8.1 kg ha<sup>-1</sup>, pero es común lograr menos del 50% de germinación (Pande y Gupta, 2013).

Las flores son pequeñas (15-17 mm) y blancas, con corolas de color púrpura pálido (Darise et al., 1983). Las diminutas flores blancas son hermafroditas y tienen órganos masculinos y femeninos, que nacen en pequeños corimbos de dos a seis flores (Bondarev et al., 2003). La planta puede iniciar la floración después de que se hayan formado un mínimo de cuatro hojas verdaderas y tarda más de un mes en pasar por las distintas etapas de desarrollo floral (Ramesh et al., 2006).

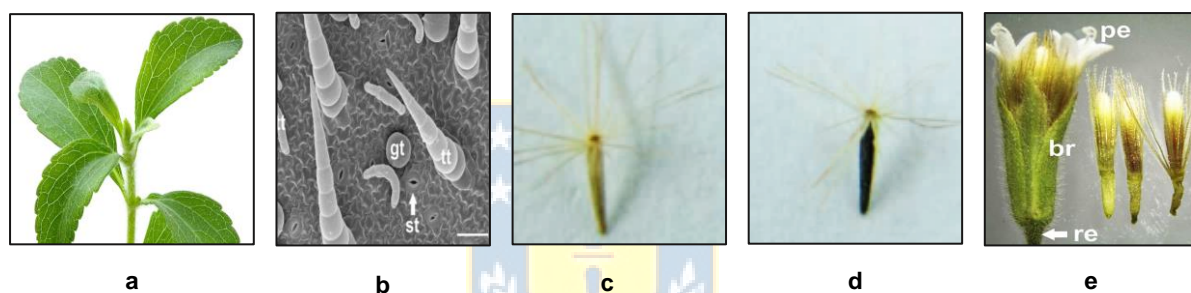
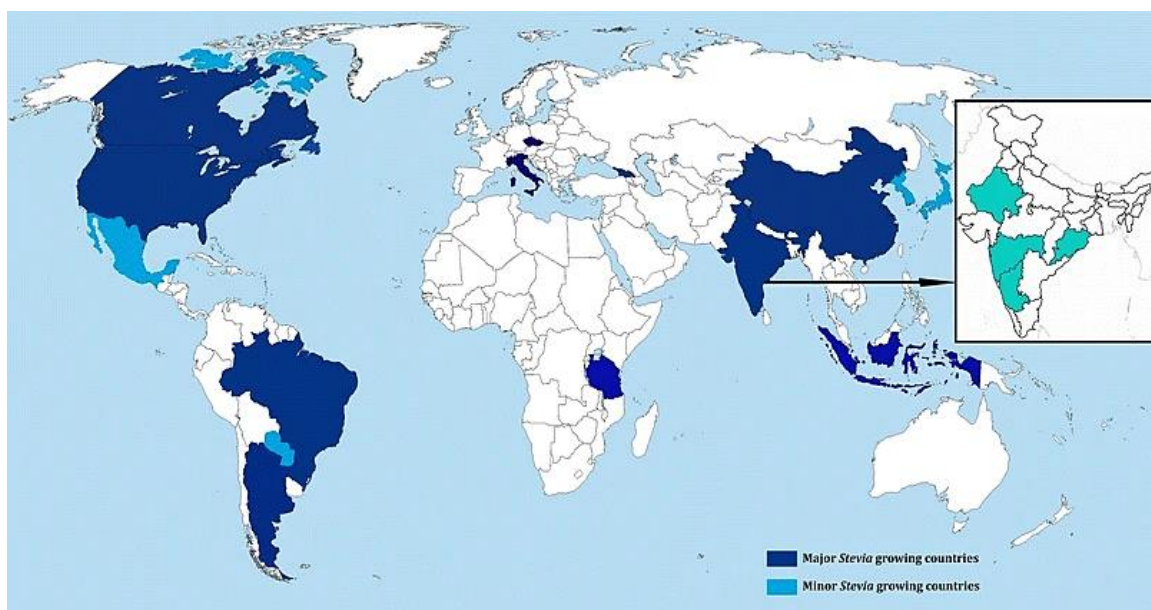

**Fig. 1.** Apariencia morfológica típica de órganos en *S. rebaudiana*, (a) hojas en posición opuesta y alternas, (b) tricomas glandulares, (c) semilla tipo aquenio color café claro (infértil), (d) semilla tipo aquenio color café oscuro (fértil), (e) flor blanca hermafrodita.

El género *Stevia* se distribuye por todo el mundo, desde el sur de EE. UU. hasta Argentina y el altiplano brasileño, pasando por México, los estados centroamericanos y los Andes Sudamericanos (Gantait et al., 2018; Peteliuk et al., 2021). *S. rebaudiana* se encuentra principalmente en altitudes que oscilan entre 500 y 3500 m sobre el nivel del mar (Gantait et al., 2018).

El hábitat natural de *Stevia* se encuentra en una latitud de 25 °S en un territorio subtropical en el noreste de Paraguay entre 500 y 1500 m sobre el nivel medio del mar, con una temperatura anual regular de 25°C y una precipitación promedio anual de alrededor de 1375 mm (Ramesh et al., 2006). En 1905 se propuso que el rango de distribución de esta planta se sitúa entre las latitudes 22° 30'-25° 30'S y longitudes 55°-57'W. En 1975 se especificó que su distribución oscilaba entre 22° y 24 latitud 'S y 55-56'W longitud, y dentro de las regiones altitudinales de 200-700 m (SCF, 1999).

La *Stevia* se cultiva como planta perenne en regiones subtropicales, incluidas partes de los Estados Unidos, y como planta anual en regiones de latitudes medias a altas (Goettemoeller y Ching, 1999). Esta extrema versatilidad ayuda a la planta a encontrar su lugar entre todas las demás plantas medicinales importantes del mundo. Teniendo en cuenta su enorme valor medicinal, la *Stevia* se acepta como un arbusto/ cultivo importante en varios países, incluidos Brasil, Canadá, Indonesia, India, Japón, Corea, México, Estados Unidos y Tanzania (Gantait et al. 2018). China es el principal centro de producción de *Stevia* y Japón se convirtió en el principal mercado (Hastoy et al., 2019). Además, en los últimos años; en la India, la *Stevia* se está cultivando en Karnataka, Rajasthan, Maharashtra y Orissa (Fig. 2).

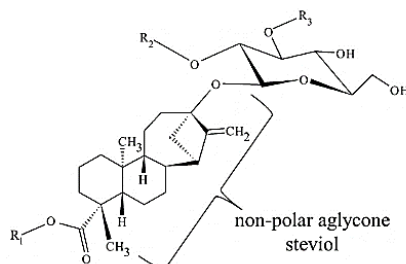

**Fig. 2.** Distribución mundial de la planta de *S. rebaudiana*, tomado de Gantait et al., (2018).

## **1.2. Composición química de *Stevia rebaudiana* (Bertoni) Bertoni (Asteraceae)**

La *S. rebaudiana* es rica en antioxidantes naturales entre los que destacan: flavonoides, fenoles, taninos, aceites esenciales y otros (Christaki et al., 2013; Zaidan et al., 2018). Se ha informado que las hojas de *Stevia* contienen una combinación compleja de compuestos denominados esteviol glicósidos (SGs), que pertenecen al grupo diterpenoide de los metabolitos especializados en plantas (Khiraoui et al., 2017). Su estructura química se basa en un núcleo de aglicona conocido como

esteviol al que mediante una familia de enzimas promiscuas (glicosiltransferasas UGTs) se le adicionan diferentes tipos y cantidades de glicósidos (Libik-Konieczny et al., 2021), (Fig. 3).



Compound/Abbreviation	R1 (C-13)	R2 (C-19)
Steviol/St	H-	H-
Steviolbioside/Stb	Glc(β1-2)Glc(β1)-	H-
Stevioside/Stv	Glc(β1-2)Glc(β1)-	Glc(β1)-
Rebaudioside A/Reb A	Glc(β1-2)[Glcβ1-3]Glc(β1)-	Glc(β1)-
Rebaudioside B/Reb B	Glc(β1-2)[Glcβ1-3]Glc(β1)-	H
Rrebaudioside C/Reb C	Rha(α1-2)[Glcβ1-3]Glc(β1)-	Glc(β1)-
Rebaudioside D/Reb D	Glc(β1-2)[Glcβ1-3]Glc(β1)-	Glc(β1-2)Glc(β1)-
Rebaudioside E/Reb E	Glc(β1-2)Glc(β1)-	Glc(β1-2)Glc(β1)-
Rebaudioside F/Reb F	Xyl(β1-2)[Glcβ1-3]Glc(β1)-	Glc(β1)-
Rebaudioside G/Reb G	Glc(β1-3)Glc(β1)-	Glc(β1)-
Rebaudioside H/Reb H	Glc(β1-3)Rha(α1-2)[Glcβ1-3]Glc(β1)-	Glc(β1)-
Rebaudioside I/Reb I	Glc(β1-2)[Glcβ1-3]Glc(β1)-	Glc(β1-3)Glc(β1)-
Rebaudioside J/Reb J	Glc(β1-2)[Glcβ1-3]Glc(β1)-	Rha(α1-2)Glc(β1)-
Rebaudioside L/Reb L	Glc(β1-6)Glc(β1-2)[Glcβ1-3]Glc(β1)-	Glc(β1)-
Rebaudioside M/Reb M	Glc(β1-2)[Glcβ1-3]Glc(β1)-	Glc(β1-2)[Glcβ1-3]Glc(β1)-
Rebaudioside N/Reb N	Glc(β1-2)[Glcβ1-3]Glc(β1)-	Rha(α1-2)[Glcβ1-3]Glc(β1)-
Rebaudioside O/Reb O	Glc(β1-2)[Glcβ1-3]Glc(β1)-	Glc(β1-3)Rha(α1-2)[Glcβ1-3]Glc(β1)-
Ruboside/Rub	Glc(β1)-	Glc(β1)-
Dulcoside A/DlcA	Rha(α1-2)Glc(β1)-	Glc(β1)-
Dulcoside B/DlcB	Rha(α1-2)[Glcβ1-3]Glc(β1)-	H-

**Fig. 3.** Estructura química de algunos glicósidos de esteviol. Glc, Rha y Xyl representan restos de azúcar de glucosa, ramnosa y xilosa, respectivamente. Tomado de Libik-Konieczny et al., (2021).

Se considera una planta medicinal, con efectos beneficiosos sobre la diabetes tipo II, al poseer glicósidos de esteviol bajos en calorías (Shahzad et al., 201). Todos los glicósidos aislados de esta

planta tienen el mismo esteviol (la aglicona de SGs), pero difieren en el contenido de sacáridos (Pacífico et al., 2017; Kang et al., 2022). Las hojas tienen el mayor contenido de esteviósido y rebaudiósido A, que son sus principales principios activos y los compuestos responsables de la edulcorancia; normalmente están acompañados por pequeñas cantidades de otros esteviolglicósidos (So et al. 2019).

Estos compuestos dulces pasan a través del proceso digestivo sin ruptura química, haciendo seguro el control de los niveles de azúcar en sangre (Geuns et al., 2003; Chatsudthipong y Muanprasat, 2009). Los extractos refinados de hojas de *S. rebaudiana* se utilizan oficialmente en Japón, Brasil, China y Corea como edulcorantes bajos en calorías en el procesamiento de alimentos, en dietas artificiales y como compuestos farmacéuticos para diabéticos, por su efecto hipoglucemiante (Ismail et al., 2020). Se demostró que el consumo del esteviósido, mejoró el perfil de lípidos al regular la expresión de genes de células beta, incluyendo factores reguladores de la transcripción de la insulina (Li et al., 2021). Además, mejoró la homeostasis de la glucosa y aumentó la sensibilidad a la insulina, al reducir los triglicéridos en plasma, favoreciendo la reducción de peso en ratones diabéticos (Anker et al., 2019).

Se han descubierto más de 100 compuestos químicos del metabolismo secundario en *S. rebaudiana* siendo los más abundantes terpenos y flavonoides. Los principales fitoquímicos aislados de Stevia incluyen: apigenina, austroinulina, avicularina, beta-sitosterol, ácido cafeico, campesterol, cariofileno, centaureidina, ácido clorogénico, cosmosina, cinarósido, daucosterol, foeniculina, ácido fórmico, giberelina, indol-3-acetonitrilo, isoquercitrina, jtanol, kaempferol, lupetina, lupetina, quercitrina, escopoletina, esterebina AH, estigmasterol, umbeliferona y xantofilas (Dona et al., 2021).

Sin embargo, se ha descrito que los principales componentes del extracto de hojas son los glicósidos de esteviol, seguidos de los alcaloides y taninos, también identificados en proporciones más altas, pero menos significativos que los glicósidos de esteviol (Basharat et al., 2021).

### I.3. Síntesis de esteviol glicósidos (SGs)

Existen divergencias de criterios cuando se estudia y se comparan las vías de síntesis de terpenos en otras especies con respecto a la *S. rebaudiana*. Varios autores han indicado que la diferencia se debe a que en esta especie el ent-kaureno, precursor de giberelinas, se convierte a esteviol en el retículo endoplásmico (Pramastya et al., 2020; Pu et al., 2021). Dos vías biosintéticas diferentes contribuyen a la síntesis de terpenos en plantas de *S. rebaudiana* (1) la vía citosólica del ácido mevalónico (MVA) que está involucrada en la biosíntesis de sesquiterpenos, triterpenos y poli terpenos, mientras que consecutivamente existe una segunda vía que ocurre en el plastidio (2) vía del fosfato de metil-eritritol (MEP) (Brandle et al., 2002; Brandle y Telmer, 2007). Sin embargo, a pesar de que existe una cantidad significativa de investigaciones sobre la actividad de estas vías en diferentes condiciones, la contribución relativa de cada vía a la biosíntesis de diversos terpenos sigue sin estar clara.

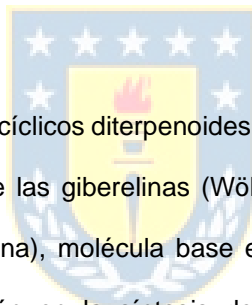

Los glucósidos de esteviol son tetracíclicos diterpenoides del tipo *ent*-kaurene y comparten cuatro pasos de su biosíntesis con la vía de las giberelinas (Wölwer-Rieck et al., 2014). *S. rebaudiana* produce en sus hojas esteviol (aglicona), molécula base e inicial de la ruta biosintética para las posteriores reacciones de glicosilación en la síntesis de esteviol glicósidos. Muchos estudios informan que el esteviol se sintetiza a partir de kaureno a través de la vía metileritrol fosfato (MEP) (Madan et al., 2010). En la primera etapa, piruvato y gliceraldehído3-fosfato (G3P) que son moléculas de síntesis del metabolismo primario, dan lugar a isopentenil difosfato (IPP) y dimetilalil difosfato (DMAPP) a través de la vía Vía MEP. La reacción de condensación, catalizada por DXS, cataliza la primera reacción en la vía MEP (Zhou et al., 2021). El piruvato y el gliceraldehído 3-fosfato (G3P) se convierten en 1-desoxi-D-xilulosa 5-fosfato (DXP) bajo la catálisis de DXS (Pu et al., 2021). DXS es la enzima llave que controla el flujo a través de la vía MEP (Lucho et al., 2018), (Fig. 4).

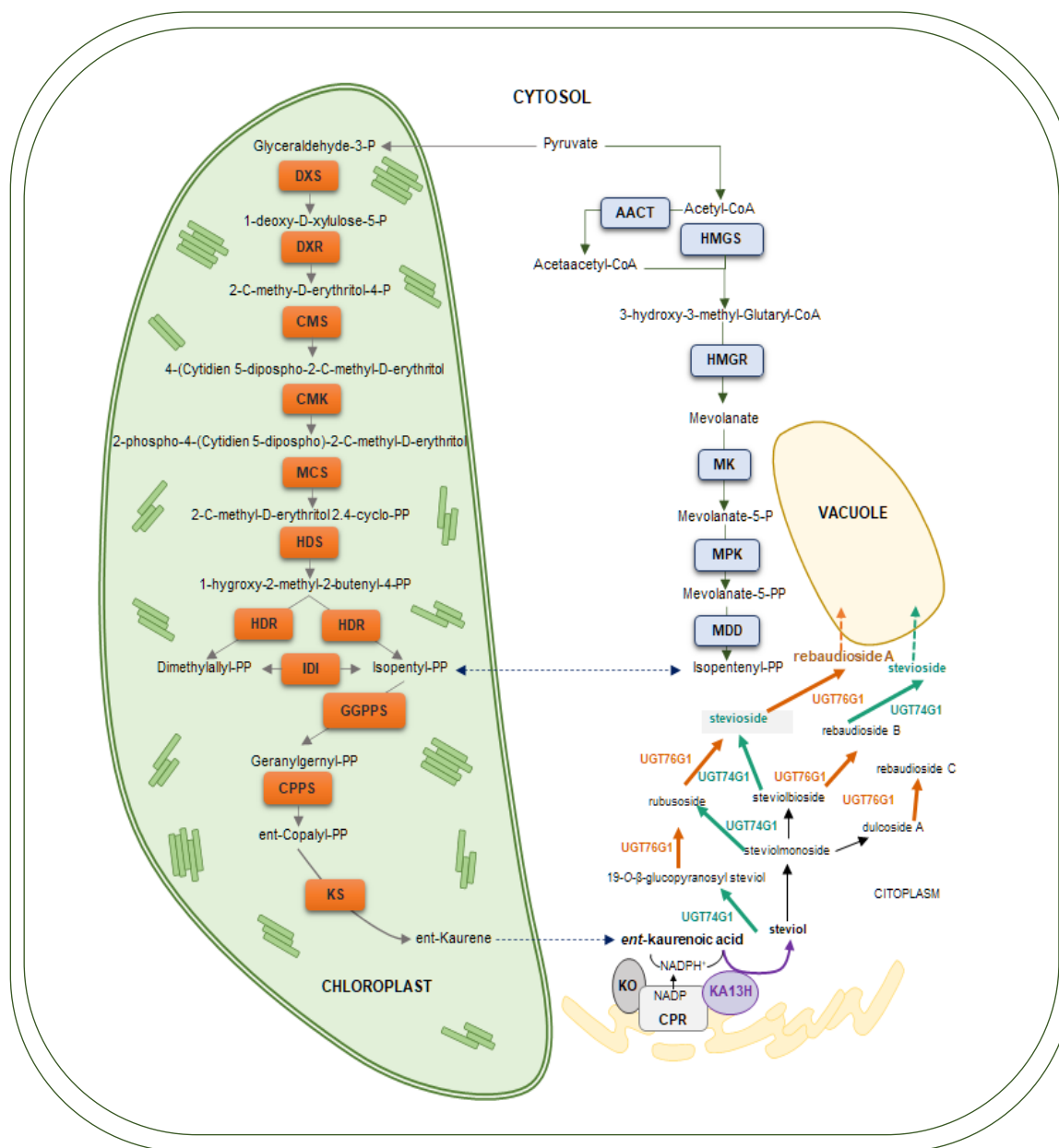

**Fig. 4.** Descripción esquemática de la vía metabólica para la síntesis de glucósidos de esteviol (SGs) y su organización subcelular en *S. rebaudiana*. En el cloroplasto, el ent-kauréno se sintetiza a través de la vía MEP, mientras que en el citosol a través de la vía del ácido mevalónico se sintetiza hasta isopentil difosfato. Posteriormente, la *ent*-kauréno oxidasa (KO) es responsable de la conversión de ent-kauréno en ácido ent-kaurénoico, que es el sustrato de ácido ent-kaurénoico 13 hidroxilasa (KA13H) para sintetizar esteviol. Tanto KO como KA13H se encuentran en el retículo endoplásmico muy cerca de citocromo P450 reductasa (CPR) que actúa como un donante necesario de NADPH. La regulación de las actividades de KO y KA13H es crucial ya que el ácido ent-kaurénoico es un punto de ramificación en la vía que conduce a la síntesis de giberelinas o SGs. Si se favorece la actividad de KA13H, se producirá esteviol. A partir del esteviol, mediante rondas consecutivas de glicosilación realizadas por diversas uridina-difosfato glicosil transferasas (UGTs) ubicadas en el citoplasma, se sintetizan múltiples SGs. Los SGs más abundantes, el esteviósido y el rebaudiósido A, se producen aguas abajo por la actividad de las enzimas altamente promiscuas UGT74G1 y UGT76G1. El esteviósido y el rebaudiósido A acumulados se transportan y almacenan posteriormente en la vacuola. Representación adaptada de Singh et al. (2017) y Libik-Konieczny et al. (2021).

Vía del ácido mevalónico (MVA): Todos los terpenos naturales proceden de unidades de acetato activo (Acetil CoA), que se condensan y transforman para originar ácido mevalónico (AMV), unidad de cinco átomos de carbono, específica de la biosíntesis de terpenos (Jacques, 2016). En la primera etapa de esta ruta sintética, por acción de una enzima tiolasa y la hidroxil- metil glutaril CoA sintetasa, se condensan tres unidades de acetil CoA y forman 3-hidroxil-3-metil glutaril CoA (HMG-CoA), compuesto que experimenta una reducción dependiente de NADPH.H<sup>+</sup>, transformándose en AMV por la acción de la HMG-CoA reductasa, ubicada en la membrana del retículo endoplasmático (RE) (Ashour et al., 2010). El AMV es activado, formándose isopentenil pirofosfato (IPP). En las reacciones de alargamiento de la cadena terpénica, IPP y dimetilalil pirofosfato (DMAPP) se condensan de cabeza a cola. El DMAPP aporta el resto isoprenoide  $\alpha$ , o inicial, formándose geranyl pirofosfato GPP (C10) (He et al., 2020). La adición sucesiva cabeza a cola de otras unidades IPP conduce a la síntesis de farnesil pirofosfato FPP (C15), geranyl geranyl pirofosfato GGPP (C20), que dará origen al diterpeno tetracíclico ent-kaureno, en una reacción catalizada por la enzima kaureno sintetasa (KS) (Mafu et al., 2016).

Ruta metabólica metileritrol 4-fosfato (MEP): Estudios más recientes han demostrado, mediante el uso de marcaje *in vivo* con [1-13C] glucosa y espectroscopía de RMN que los precursores del esteviol son en realidad sintetizados a través de la vía metil eritritol 4-fosfato, localizado en plastidios (Mathur et al., 2017). Estos últimos resultados son indicativos de una posible compartimentación de las dos vías en *S. rebaudiana* (Lucho et al., 2021).

Según los autores, en esta ruta alternativa llamada vía MEP, el primer compuesto intermediario, 1 deoxi-d-xilulosa-5-fosfato (DXP), se forma a partir de los productos del catabolismo de la glucosa, piruvato y d-gliceraldehído-3- fosfato, por una tiamina sintasa difosfato-dependiente (Nagegowda y Gupta, 2020; Srinath et al., 2021). Una reducto-isomerasa cataliza la reestructuración de la cadena de DXP, así como la subsecuente reducción del aldehído resultante (NADPH-dependiente), a la forma 2-C-metil-d-eritritol 4-fosfato (MEP), el cual podría representar el primer intermediario comprometido en esta ruta metabólica (Lyu et al., 2019). Los pasos siguientes involucran la conversión del MEP en ME 2,4-ciclodifosfato, vía 4- difosfocitidil ME y 4- difosfocitidil ME 2-fosfato;

los cuales, por pasos aún desconocidos, que involucran la reducción y eliminación de moléculas de agua, darían origen a IPP y DMAPP, a partir de los cuales se siguen normalmente los pasos que se proponen para la ruta del MVA (Koeduka et al., 2020).

Tras el descubrimiento de las propiedades diterpenoides de esteviol, la biosíntesis de la unidad diterpénica del esteviósido comienza con la adición de unidades IPP a dimetilalil difosfato para producir difosfato de geranylgeranilo (GGPP). El GGPP se convierte en ent-kaureno a partir de la copalyl-difosfato sintasa (CPPS) y la kaureno sintasa (KS) a través de la liberación de energía, y luego genera ácido ent-kaurenoico (ent-KA) a través de la reacción de oxidación de tres pasos de KO (Gold et al. 2018). Los CPS y KS de *S. rebaudiana* han sido aislados y caracterizados a partir de CPPS y KS recombinantes se ha probado su actividad catalítica, lo que demuestra que los genes CPPS y KS están involucrados en la biosíntesis de esteviol glicósidos (Richman et al., 2005). A continuación, bajo la catálisis de KAH, la reacción de hidroxilación de ent-KAH en C13 es el paso clave para generar SGs (Kim et al. 2015). Sin embargo, en otras especies la reacción ocurre sobre la posición C7 del diterpeno generando GA (Salazar-Cerezo et al., 2018; Tavakoli et al., 2019).

Aunque las reacciones catalizadas por CYP son extremadamente diversas, por lo general se basan en catalizar la inserción de un átomo de oxígeno molecular en el sustrato y la reducción de otro átomo para formar agua, de allí que se clasifiquen como monooxigenasas (Guengerich, 2018). Los CYP450 son proteínas solubles en procariontes, generalmente unidas al retículo endoplásmico (RE) o membranas mitocondriales internas cuando están en eucariotes (Werck-Reichhart y Feyereisen, 2000). La actividad de los CYP depende de la transferencia de dos electrones, catalizada por la enzima citocromo P450 reductasa dependiente de NADPH (CPR) (Ebrecht et al., 2019). Los complejos CYP y CPR son unidos por interacciones proteína-proteína, donde la CPR es el nodo de la subunidad CYP y otras proteínas relacionadas en sus propios tejidos (Bassard et al. 2017; Gold et al. 2018).

La hidroxilación en C-13 del ácido ent-kaurenoico catalizado por la ácido ent-kaurenoico 13-hidroxilasa (KA13H) conduce al esteviol (Wölwer-Rieck 2018). Tanto el KO como el KA13H funcionan



con el apoyo del citocromo P450 reductasa (CPR) dependiente de NADPH, trabajando en proximidad molecular (Gold et al., 2018; Zhang y Hong, 2020). Después de la formación de esteviol, se produce una serie de glicosilaciones por las glicosiltransferasas uridina-difosfato (UGT) (enzimas promiscuas) en el citosol, lo que lleva a la producción de diferentes SGs. La diversidad de SGs se debe al número, la posición y la naturaleza de la glicosilación en los grupos hidroxilo en C-13 y C-19 del esteviol (Li et al., 2021). A partir del esteviol, los pasos adicionales implican la glicosilación de esteviolmonósido para formar esteviolbiósido mediante una UGT desconocida, seguido de la glicosilación de esteviolbiósido catalizada por UGT74G1 que produce esteviósido, y luego, la glicosilación de esteviósido catalizada por UGT76G1 para formar rebaudiósido A (Lee et al.2019). Aquí, se estima que son UGT74G1 y UGT76G1 las que participan en varios pasos de la vía de SGs (Fig.4). Esta promiscuidad parece que se extiende más allá, ya que se ha demostrado recientemente que estas enzimas pueden aceptar una serie de alcoholes, polifenoles, y glucósidos como sustratos cuando se analizan *in vitro* (Xu et al., 2021). Actualmente, la vía de glicosilación aún no se comprende completamente y se requiere una investigación detallada para comprender mejor su regulación (Libik-Konieczny et al., 2021).

La velocidad con la que avanzan las investigaciones en el área de la bioquímica vegetal y la genómica han permitido que en corto tiempo se logren dilucidar y comprender rutas del metabolismo secundario en plantas como la *S. rebaudiana*. Actualmente, se conoce que la síntesis de glicósidos de tipo esteviol está restringida a tejidos verdes. Se han descrito los pasos que conducen a la síntesis del ácido *ent*-kaurenoico y se ha explicado la posible compartimentación de las reacciones metabólicas que ocurren en los plastidios, así como los dos pasos de oxidación que ocurren en la superficie del retículo endoplasmático ER y la glicosilación que ocurre en el citoplasma. La posibilidad de que la síntesis de esteviol glicósidos pueda suceder tanto por la vía del mevalonato como por la del MEP genera un sin número de interrogantes sobre la posible actividad biológica de estos compuestos en la planta.

A pesar de los numerosos estudios realizados sobre especies medicinales, aún falta mucho por conocer sobre los procesos de síntesis de metabolitos especializados y su regulación, tanto en

términos de rutas metabólicas y enzimas involucradas; como de factores internos y externos que afectan su acumulación (Suttipanta et al. 2011). En las rutas metabólicas de síntesis de glicósidos en *S. rebaudiana* participan numerosos genes y enzimas, algunos de los cuales han podido ser identificados y caracterizados. Una mejor comprensión de la regulación genética de las vías de biosíntesis podría ser muy útil para optimizar el rendimiento de compuestos edulcorantes en Stevia. Además, la comprensión de los mecanismos de síntesis de estos compuestos, y su expresión ante diferentes condiciones de estrés, permitiría explicar su función biológica en la planta y seleccionar cultivares que se adapten a diferentes condiciones ambientales y zonas geográficas.

Sin embargo, la investigación sobre las vías de glicosilación en sentido descendente es relativamente escasa y aún deben resolverse muchos problemas. Por ejemplo, no se han dilucidado las SGs biosintéticas de ramnosilación y xilosilación. La estructura cristalina de la glucosa glicosiltransferasa relacionada y el mecanismo catalítico, siguen siendo desconocidos. El mecanismo de transformación mutua de muchos SG diferentes aún no está claro, por ejemplo, cómo se traduce Reb I a Reb M. Por lo tanto, el descubrimiento funcional y la identificación de la enzima diana de la vía biosintética codificada por el gen son fundamentales para comprender la actividad glicosiltransferasa, regular la síntesis de estos metabolitos y conocer sobre su rol biológico en la planta, comparándolo con el de otras especies.

#### **I.4. Propagación de *S. rebaudiana***

La *S. rebaudiana* es una planta de reproducción sexual por fecundación cruzada (alógama), condición que origina variabilidad fenotípica y variedad en la composición de los principios activos en las hojas, lo que genera una oportunidad para seleccionar plantas sobresalientes para la comercialización (Oviedo-Pereira et al. 2015). Sin embargo, la reproducción por semillas no es recomendable debido los bajos porcentajes de germinación. La reproducción sexual se realiza por medio de semillas en el interior de aquenios. Trabajar con semillas es difícil considerando que son pequeñas y pierden rápidamente su poder germinativo. La recolección es lenta y difícil, debido a una floración no uniforme, lo que afecta la maduración de la semilla; además presentan una amplia

variación en el contenido de esteviósidos (5-15% del peso seco), así como en las características morfológicas, tales como la forma y el color de las hojas. El porcentaje de germinación puede variar entre un 10 y 38%. La reproducción asexual es la más recomendada para la propagación de esta especie vegetal. Esta, generalmente se realiza por medio de esquejes, hijuelos o cultivo *in vitro* con la finalidad de conservar las características fenotípicas y genotípicas de la planta progenitora. Además, se asegura la homogeneidad de las plantas y mejora el rendimiento de esteviósidos (Aman et al. 2013; Vázquez-Baxcajay et al. 2014).

#### **I.4.1. Cultivo *in vitro* de *S. rebaudiana***

Las ventajas de la micropropagación, respecto a sistemas convencionales, son el incremento acelerado del número de plantas, la disminución del tiempo de multiplicación, un mayor número de plantas por superficie utilizada, mayor control de la sanidad, fácil transporte para intercambio de materiales y la posibilidad de multiplicar rápidamente especies en peligro de extinción (Espinosa-Leal et al., 2018). La propagación *in vitro* o micropropagación de *S. rebaudiana*, ha mostrado ser un método que garantiza alta eficiencia y estabilidad genética de las plantas producidas. Sin embargo, los estudios de producción masiva *in vitro* de esta especie son limitados (Madan et al. 2010; Aman et al., 2013; Ramírez-Mosqueda et al. 2016); y trabajos recientes enfatizan la necesidad de técnicas para la producción *in vitro* de los esteviósidos y rebaudiósidos (Cantabella et al. 2017) o incrementar el material vegetativo por organogénesis con este fin (Vázquez-Baxcajay et al., 2014; Yoneda et al. 2017; Jain et al. 2019).

La composición y contenido de esteviol glicósidos en el cultivo *in vitro* de *S. rebaudiana* ha sido investigada por varios autores (Bondarev et al. 2003; Dey et al., 2013; Cantabella et al. 2017; Yoneda et al. 2017). Un análisis comparativo de la producción de estos compuestos entre plantas que crecen en ambiente natural, plantas *in vitro*, callos desdiferenciados, suspensiones celulares y brotes regenerados *in vitro*, demostró idéntica composición cualitativa; sin embargo, el contenido de los diterpenos en las plantas *in vitro* fue de cinco a seis veces más bajo que en las plantas intactas (Bondarev et al. 2003).

La alta plasticidad de la célula vegetal le permite transitar por estas diferencias con una reprogramación de los sistemas enzimáticos y sobrevivir a las condiciones externas después del crecimiento *in vitro*. Uno de los problemas fundamentales para la supervivencia *ex vitro* es la pobre capacidad fotosintética desarrollada (Haisel et al., 2004), relacionada con las restricciones de CO<sub>2</sub> y la baja intensidad luminosa del cultivo *in vitro* (Arigita et al., 2002). Para disminuir los efectos del cambio de ambiente *in vitro* a *ex vitro* se requiere de una fase de aclimatación, en la que las plantas se adaptan gradualmente a las nuevas condiciones ambientales (Fila et al., 2006; Jitendra et al., 2012).

Algunos investigadores han abordado el estudio del estrés por luz en las plantas después de cultivadas *in vitro*. Otro de los factores a tener en cuenta es la humedad relativa, que durante el cultivo *in vitro* es muy alta. Debido al escaso control que poseen las plantas en la transpiración se requiere de un cambio gradual desde una alta humedad hasta una baja humedad relativa durante la fase *ex vitro*, es por ello, que el desarrollo gradual del aparato estomático es vital en esta etapa (Acosta-Motos et al., 2019; Shulgina et al., 2021).

La temperatura es otro de los factores que puede afectar la aclimatación de las plantas y es considerablemente mayor *ex vitro* que en las condiciones *in vitro*. El ciclo día-noche en condiciones *ex vitro* expone a las plantas a variaciones de temperatura. La protección que brinda los invernaderos con condiciones controladas y el uso de cubiertas oscuras son variantes que se utilizan para disminuir las altas temperaturas que se alcanzan en el medio día del verano de los países tropicales y subtropicales. Durante la noche las temperaturas descienden, pero no a valores tan bajos como en el invierno de países más alejados del trópico, donde este factor constituye un problema por el congelamiento y muerte de las plantas (Soufi et al. 2016). La fase *ex vitro* en comparación con la fase *in vitro* transcurre con grandes diferencias en cuanto a la disponibilidad de nutrientes como azúcares y sales minerales. En la fase *in vitro* existe mayor disponibilidad de nutrientes que la planta adquiere del medio de cultivo, además se incluyen reguladores del crecimiento, mientras que en la *ex vitro* todo está limitado a agua, sales minerales y condiciones fotoautotróficas (Hajjhashemi et al. 2018).

Entre los métodos biotecnológicos de propagación masiva de plantas los Biorreactores de Inmersión Temporal (BIT®) son altamente ventajosos, al presentar un sistema de cultivo parcialmente abierto, con medio líquido, renovación del espacio gaseoso, menor manipulación, lo que aporta una mayor cantidad y mejor calidad morfológica de las plantas (Ramírez-Mosqueda et al. 2016).

El cultivo en sistemas de inmersión temporal se ha diseñado para cultivos intensivos y a menudo escalados. Tienen la ventaja de monitorear y controlar las condiciones microambientales, mejorando el suministro de nutrientes y la transferencia de gases, con el fin de reducir trastornos fisiológicos, como la hiperhidricidad y, por tanto, preservar la integridad morfológica de los cultivos micropropagados. Estos sistemas proporcionan un ambiente *in vitro* para cultivos de tejidos y órganos de plantas, donde los propágulos cultivados se sumergen durante un cierto período de tiempo en un medio líquido y luego se exponen a un ambiente gaseoso (Georgiev et al., 2014).

El sistema Twin-Flask (Biorreactores de Inmersión Temporal) es uno de los primeros BIT desarrollados. Básicamente, el sistema Twin-Flask consta de dos recipientes (frascos de boca ancha), conectados entre sí por un tubo en U (vidrio o plástico) o un tubo de silicona (Fig. 5). Uno de los recipientes tiene la función de cámara de cultivo, mientras que el otro, se utiliza como tanque de almacenamiento del medio. El recipiente de la cámara de cultivo puede o no estar equipado con material de soporte para las plantas (se pueden usar perlas de vidrio, espuma de poliuretano, tamices de metal o nailon) en su parte inferior (Lai et al., 2005). Cada contenedor está conectado a su propia línea de aire presurizado, controlada por dos relojes temporizadores independientes, junto con válvulas solenoides de tres vías. (Escalona et al., 2003; Georgiev et al., 2014; Badjakov et al., 2021). El diseño simple y confiable hace que los sistemas Twin-Flask sean favorables para su implementación en laboratorios comerciales. Debido a que son fáciles de operar y su uso permite mantener la esterilidad durante largos períodos de cultivo.

Otros autores señalan que con la inmersión temporal el comportamiento general de los brotes se asemeja más a las plantas crecidas *ex vitro* y una causa importante es la renovación periódica del espacio gaseoso del frasco de cultivo, lo que reduce la humedad relativa e incrementa la asimilación

de agua y nutrientes (Teisson and Alvard 1995). Por otra parte, debido a las inmersiones los explantes quedan recubiertos por una fina película de medio líquido que evita la desecación sin obstaculizar la difusión de los gases (Sairkar et al. 2009; Noordin et al. 2012).

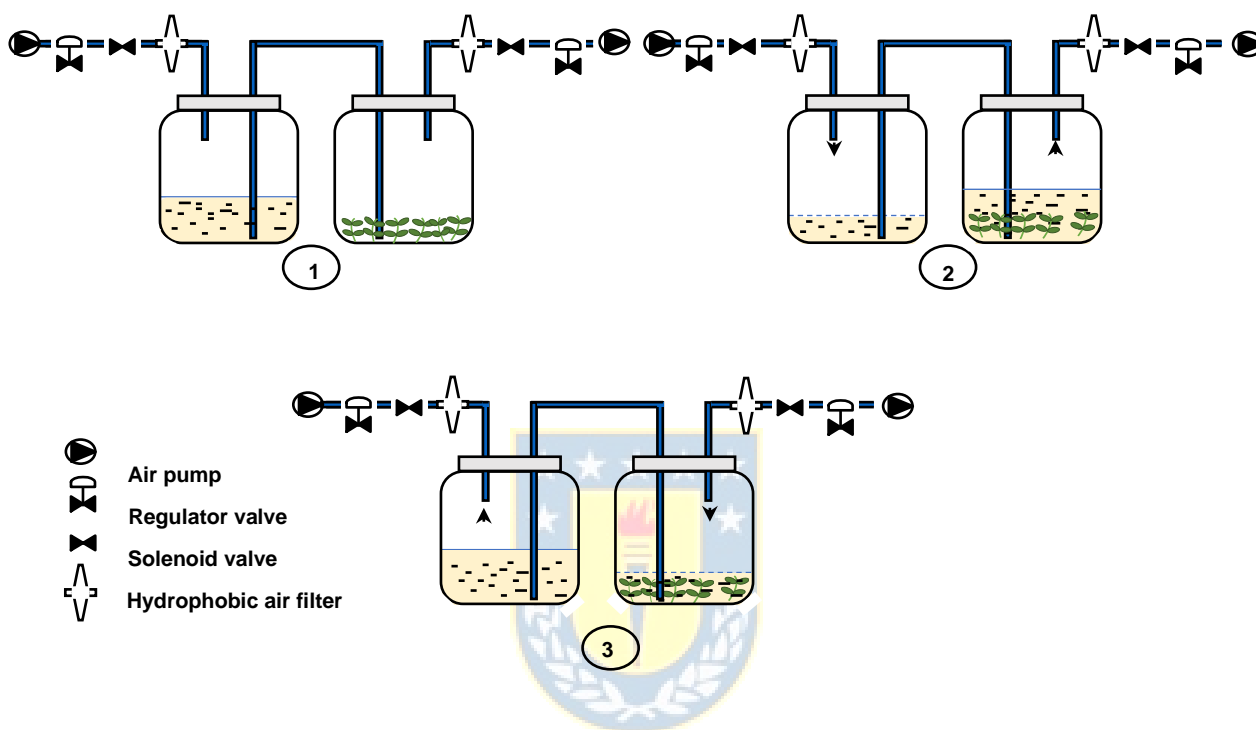

**Fig. 5.** Ciclo de funcionamiento de los Biorreactores de Inmersión Temporal (BIT®). (1) Etapa no sumergida, los brotes se colocan sobre el fondo del recipiente de cultivo, (2) Inicio de la etapa de inmersión; se aplica una sobrepresión y el medio se empuja hacia el contenedor de la planta, sumergiendo los brotes durante unos minutos, (3) al final de la etapa de inmersión, se abre una segunda válvula solenoide y se retira el medio de cultivo al depósito. La bomba de aire y las válvulas eléctricas son controladas por un temporizador (Escalona et al., 2003).

Algunas de las principales desventajas de los sistemas Twin-Flasks son la automatización integral (la necesidad de relojes de dos temporizadores y dos válvulas solenoides de tres vías) y la falta de opciones para la renovación del medio nutritivo y la ventilación forzada, puesto para el suministro externo de CO<sub>2</sub> durante el período de exposición. Sin embargo, se puede usar aire enriquecido con CO<sub>2</sub> para asegurar concentraciones más altas de CO<sub>2</sub> en el ambiente gaseoso de la cámara de cultivo (Lai et al., 2005; Ducos et al., 2007; Gago et al., 2021). Los sistemas Twin-Flask se han

aplicado con éxito en la propagación de plántulas de plantas, brotes, racimos de nódulos y cultivos de embriones (Supaibulwattana et al., 2011). Recientemente, los sistemas Twin-Flask también se han utilizado en trabajos de investigación sobre la acumulación de metabolitos especializados mediante cultivos *in vitro* diferenciados (Weckx et al., 2019; Gago et al., 2021). Estos sistemas pueden ser muy eficientes; para obtener vitro-plantas para el cultivo extensivo de *S. rebaudiana* y como una vía de producción de la biomasa para obtener metabolitos bajo condiciones controladas.

Las características morfoanatómicas de las plantas cultivadas *in vitro* obedecen en gran medida al microambiente de los frascos de cultivos, como resultado de la interacción de diferentes factores tales como la intensidad de la luz, la concentración de CO<sub>2</sub> y la composición del medio de cultivo. Por otra parte, existen muchas diferencias entre la fase *in vitro* y *ex vitro*; las altas concentraciones de azúcares y nutrientes favorecen una nutrición heterotrófica en la fase *in vitro*. Sin embargo, se ha demostrado que muchas plantas *in vitro* continúan con características autotróficas y realizan una baja actividad fotosintética. Debido a este comportamiento surge el término “mixotrofismo”, mezcla de nutrición autótrofa con heterótrofa (Aragón et al. 2014).

La eficiencia de los BIT para la micropropagación de cultivos de importancia comercial es incuestionable. Estos sistemas tienen aplicaciones potenciales para la producción de metabolitos secundarios derivados de plantas con alto valor agregado (Steinmacher et al., 2011). El potencial de la combinación de raíces peludas transformadas con las características de los BIT, puede combinarse para el desarrollo de instalaciones biológicas locales para el tratamiento de aguas residuales contaminadas con fenol. Sin embargo, aún no se ha revelado todo el potencial de la tecnología de inmersión temporal para la fitorremediación de desechos industriales. El principio operativo y la opción de control total del contacto entre los explantes cultivados y el medio líquido, hacen de los BIT una técnica atractiva para mejorar los protocolos existentes para la transformación genética de plantas.

Las semillas de *S. rebaudiana* presentan poco vigor, por tanto, la propagación por esta vía no permite obtener poblaciones homogéneas. Además, es necesario establecer las condiciones

ambientales para que funcione el cultivo, en dependencia de la ubicación geográfica y el cultivar. La propagación se realiza mayormente por estacas; pero existen problemas en su cultivo, dados por su heterosis natural y autoincompatibilidad, que conduce a pérdidas de fertilidad. Aunque se cultiva desde la frontera de China con Rusia donde nieva, hasta el trópico, su desarrollo requiere de varias condiciones y en Latinoamérica, su explotación industrial comenzó hace pocos años. En Chile, no existen plantaciones a gran escala; sin embargo, las condiciones edafoclimáticas son apropiadas para el desarrollo de la especie, y el éxito de su cultivo depende de una buena selección varietal y atenciones culturales adecuadas.

En la actualidad, existe en el mundo una gran expectativa sobre el cultivo de *S. rebaudiana*, por su importancia no sólo en el mercado de edulcorantes, sino también en la agricultura, la ganadería, la industria farmacéutica y la cosmetología. Se estima que su consumo mundial se cuadruplicará a partir del 2020, por la tendencia en los consumidores de preferir alimentos naturales. Se considera una especie única, en cuyas hojas se acumulan más de 30 tipos de SGs (Petit et al., 2020). Al ser una planta de ciclo corto, puede ser ideal para estudiar patrones de glicosilación en metabolitos especializados tipo terpenos. A pesar de los múltiples estudios que se realizan en esta especie, las enzimas involucradas en la síntesis de estos metabolitos y sus mecanismos de regulación *in vivo*, no han sido totalmente explicados. El manejo adecuado de las condiciones de cultivo y el conocimiento sobre los factores genéticos y ambientales que influyen en la síntesis de esteviol glicósidos, puede contribuir al conocimiento de su función biológica y provocar cambios favorables para la acumulación de los SGs, deseados según sus potenciales usos.



## Hipótesis

“La propagación de cultivares de *S. rebaudiana* B., bajo condiciones foto-autotróficas induce cambios en el contenido SGs (steviosido; rebaudiosido A) y la expresión génica de las principales enzimas reguladoras de la ruta metabólica (*SrKA13H*; *SrUGT74G1*; *SrUGT76G1*)”.

## Objetivo general

Demostrar que las condiciones foto-autotróficas generan cambios morfológicos favorables para la síntesis de SGs (steviosido y rebaudiosido A) de *S. rebaudiana*, en comparación con los métodos de micropropagación convencional.

## Objetivos específicos

1. Comparar los niveles expresión génica de *SrKA13H*; *SrUGT74G1*; *SrUGT76G1* y la producción de SGs (steviosido y rebaudiosido A) en plantas de *S. rebaudiana* de los cultivares Morita II y Criolla, crecidas bajo condiciones foto autotróficas, en invernaderos.
2. Determinar el efecto de diferentes intensidades lumínicas sobre la expresión relativa génica de *SrKA13H*; *SrUGT74G1*; *SrUGT76G1* y la síntesis de esteviosido y rebaudiosido A, en plantas de *S. rebaudiana in vivo*.
3. Determinar la influencia del proceso de transición *in vitro* a *ex vitro* de vitroplantas de *S. rebaudiana* (cultivar Morita II) en la expresión relativa génica de *SrKA13H*; *SrUGT74G1*; *SrUGT76G1* y la síntesis de esteviosido y rebaudiosido A.
4. Establecer la influencia de diferentes métodos de cultivo *in vitro* de *S. rebaudiana*, cv. Morita II, (medio semisólido, líquido y sistemas de inmersión temporal) sobre la síntesis de SGs (steviosido y rebaudiosido A).

## II. CAPÍTULO I. Effect of light intensity on steviol glycosides production in leaves of *Stevia rebaudiana* plants

Published Article Nov 2021

Journal Cover

<https://doi.org/10.1016/j.phytochem.2021.113027>

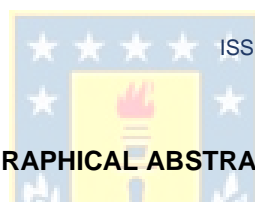

ISSN 0031-9422; Cite Score 5.5; Impact Factor 4.072

### GRAPHICAL ABSTRACT

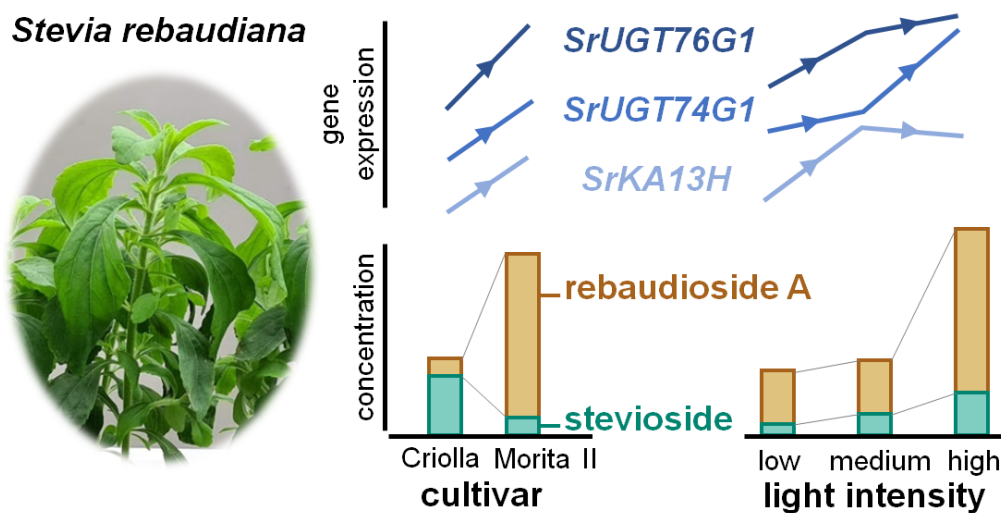

When *Stevia rebaudiana* cultivar Morita II was grown under different light intensities, the transcriptional levels of the steviol glycoside (SG) biosynthetic enzymes *SrKA13H*, *SrUGT74G1* and *SrUGT76G1* was augmented by higher light intensity, favoring increased production of SGs.

**Effect of light intensity on steviol glycosides production in leaves of *Stevia rebaudiana* plants**

Karel Vives Hernández<sup>a,b\*</sup>, Jordi Moreno-Romero<sup>b,c</sup>, Martha Hernández de la Torre<sup>d</sup>, Claudia Pérez Manríquez<sup>a</sup>, Darcy Ríos Leal<sup>d</sup>, Jaime F. Martínez-García<sup>b,c</sup>

<sup>a</sup> Faculty of Natural Sciences and Oceanography. Universidad de Concepción, Victoria 631, Barrio Universitario, Casilla 160-Correo 3, Concepción, Chile.

<sup>b</sup> Centre for Research in Agricultural Genomics (CRAG), CSIC-IRTA-UAB-UB, Barcelona, Spain.

<sup>c</sup> Institute for Plant Molecular and Cellular Biology (IBMCP), CSIC-UPV, Valencia, Spain.

<sup>d</sup> Faculty of Forestry Sciences and Biotechnology Center. Universidad de Concepción, Victoria 631, Barrio Universitario, Casilla 160-Correo 3, Concepción, Chile.

\* Corresponding author. Faculty of Natural Sciences and Oceanography. Universidad de Concepción, Victoria 631, Barrio Universitario, Casilla 160-Correo 3, Concepción, Chile.

Tel.: +56 9 6775 7281

E-mail address: kvives@udec.cl

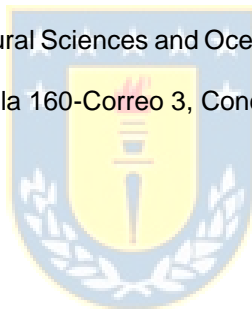
**Highlights**

- *Stevia rebaudiana* steviol glycosides levels and biosynthetic genes are studied
- The cultivar Criolla accumulates less rebaudioside A than the cultivar Morita II
- Light intensity impacts on the levels of stevioside and rebaudioside A
- Biosynthetic genes expression differs between cultivars and light intensity

## Abstract

*Stevia rebaudiana* leaf extracts contain stevioside and rebaudioside A, two steviol glycosides (SGs) used as natural sweeteners because of their non-toxic, thermally stable and non-caloric properties. Indeed, leaf extracts can be up to 300 times sweeter than sucrose. Stevioside and rebaudioside A have organoleptic differences, the first one having an undesirable bitterness and the second one a higher sweetener capacity. Selection of the *S. rebaudiana* varieties and the best environmental conditions that elicit higher SGs content and the appropriate composition is an important goal. In this study we quantified and compared the amount of stevioside and rebaudioside A in two of the most used *S. rebaudiana* cultivars, Morita II and Criolla. Our results show a strong differential ratio of stevioside and rebaudioside A accumulated in the leaf between these cultivars. The Criolla cultivar showed about 3 times more stevioside per mg of dry weight than Morita II, whereas the Morita II accumulated almost 10 times more rebaudioside A than that produced in Criolla. We observed an enhanced expression in Morita II of three genes (*SrKA13H*, *SrUGT74G1* and *SrUGT76G1*) known to encode three enzymes that participate in SGs biosynthesis, likely contributing to the differences in the stevioside and rebaudioside A accumulation. Not only genetic variation can affect SGs composition, but also environmental factors and crop management. Numerous studies have shown that the light regime in which *S. rebaudiana* cultivars grow can affect SGs accumulation. However, the optimal light regime to increase total SGs content is currently controversial. By applying various light intensities, we detected an increase of expression of these three biosynthetic genes at higher light intensity, accompanied by higher levels of stevioside and rebaudioside A, demonstrating that light intensity influences the synthesis of SGs.

**Keywords:** *Stevia rebaudiana*; Asteraceae; quantification and gene expression; steviol glycosides; stevioside; rebaudioside A; *SrKA13H*; *SrUGT74G1*; *SrUGT76G1*.

## 1. Introduction

*Stevia rebaudiana* (Bertoni) Bertoni (Asteraceae) is a perennial plant widely known for the accumulation of diterpene glycosides, which confer to their leaves strong sweetening properties. Particularly in *Stevia*, these compounds are called steviol glycosides (SGs) which are natural, non-nutritive, calorie-free, non-toxic, and intensely sweet (Madan et al. 2010; Ahmed and Mukta 2017). In addition, SGs have important medicinal applications (Abdelsalam et al., 2019; Arumugam et al., 2020). Till date there are described at least 30 different SGs (Ceunen et al., 2013a), which can constitute 4-20% of the dried weight of leaves (Lemus-Mondaca et al., 2012; Khiraoui et al., 2021). Of all SGs in *S. rebaudiana*, the most abundant are stevioside (4-13% of leaves dry weight), and rebaudioside A (2-4%), being both the major compounds responsible for the sweetness: organoleptic analysis has shown that stevioside is 300 times sweeter than sucrose, and rebaudioside A 250-450 times (Ahmed and Mukta 2017). However, stevioside is bitter or stringent when it is tasted. For that reason, the proportion of stevioside and rebaudioside A accumulated in the leaves will be an important agronomical trait.

Although the complex biosynthetic pathway of SGs remains largely unknown (Petit et al., 2020), several authors have described the main routes (Totté et al. 2003; Brandle and Telmer, 2007; Kumar et al., 2012; Dasgupta et al., 2020). The initial steps of SGs synthesis take place in the plastids following the multi-step methylerythritol 4-phosphate (MEP) pathway that results in the production of isopentenyl diphosphate (IPP) and dimethylallyl diphosphate (DMAPP), which are the units required to produce the *ent*-kaurene (Fig. II.1). Afterwards, the *ent*-kaurene oxidase (KO) is responsible of generating *ent*-kaurenoic acid. This product is an important branching point on the regulation of the SGs synthesis pathway as the plant hormones gibberellins (GAs) also derive from *ent*-kaurenoic acid. Therefore, SGs and GAs partially share biosynthetic pathways. The hydroxylation at C-13 of the *ent*-kaurenoic acid catalysed by *ent*-kaurenoic acid 13-hydroxylase (KA13H) leads to steviol (Wölwer-Rieck 2018). Either the KO or KA13H function with the support of a NADPH-dependent cytochrome P450 reductase (CPR), working in molecular closeness (Gold et al., 2018; Zhang and Hong, 2020). Following steviol formation, a series of glycosylations by the uridine-diphosphate glycosyltransferases

(UGTs) occur in the cytosol, leading to the production of different SGs. The diversity of SGs is due to the number, the position, and the nature of glycosylation on the hydroxyl groups in C-13 and C-19 of steviol (Li et al., 2021). From steviol, further steps involve glycosylation of steviolmonoside to form steviolbioside by an unknown UGT, followed by UGT74G1-catalysed glycosylation of steviolbioside that yields stevioside, and next, UGT76G1-catalysed glycosylation of stevioside to form rebaudioside A (Lee et al., 2019). Here the promiscuous role of UGT74G1 and UGT76G1 appears to participate in several steps of the SGs pathway (Fig. II.1), but also seems that it extend beyond as it has been recently shown that these enzymes can accept an array of alcohols, polyphenols, substituted monophenols, and glycosides as substrates when assayed *in vitro* (Xu et al., 2021). Currently, the glycosylation pathway is not yet fully understood and still requires detailed research to better understand its regulation (Libik-Konieczny et al., 2021).

The concentration and composition of SGs differ among cultivars. The constant crossbreeding of *S. rebaudiana*, that is a self-incompatible plant, contributes to a high level of natural variability between varieties. This generates changes in the production of SGs and variations in their sweetening capacity (Yadav et al., 2011). Therefore, the adequate selection of cultivars is crucial to efficiently produce specialized metabolites with greater sweetening power (Gantait et al., 2018). The search and phytochemical characterization of *S. rebaudiana* varieties with higher levels of rebaudioside A is one of the primary objectives for research groups and industries interested with the improvement and use of this source of natural sweeteners (Dacome et al., 2005; Razik et al., 2018). Currently, there are about 90 varieties of *S. rebaudiana* developed worldwide (Mizutani 2002; Thiyagarajan and Venkatachalam 2012). Among them, the most known and studied cultivars of *S. rebaudiana* are the cultivars Criolla and Morita II (Tavarini et al., 2018). The Criolla cultivar (native to Paraguay) is commonly used because it has been grown successfully under a wide range of climatic conditions (Angelini and Tavarini 2014). Meanwhile, the Morita II variety (which was obtained by plant breeding) is widely used due to its high yield of rebaudioside A (Aranda-González et al., 2015).

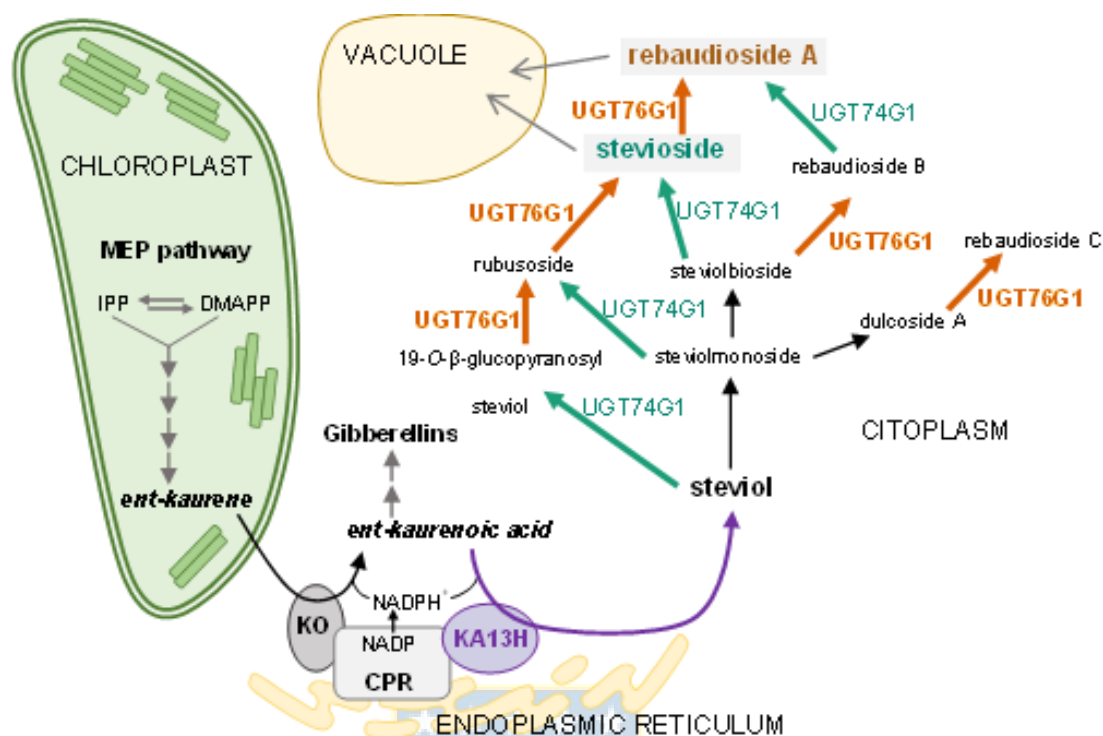
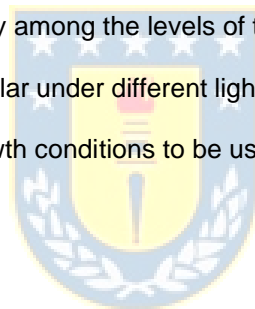

**Fig. II.1.** Schematic overview of the metabolic pathway for steviol glycosides (SGs) synthesis and its subcellular organization in *S. rebaudiana*. In the chloroplast, the ent-kaurene is synthesized through the MEP pathway. Afterwards, the ent-kaurene oxidase (KO) is responsible for the conversion of ent-kaurene to ent-kaurenoic acid, that is the substrate for the ent-kaurenoic acid 13 hydroxylase (KA13H) to synthesize steviol. Both KO and KA13H are located in the endoplasmic reticulum in close proximity to the cytochrome P450 reductase (CPR) that acts as a necessary NADPH donor. The regulation of KO and KA13H activities is crucial as ent-kaurenoic acid is a branching point in the pathway that leads either to the synthesis of gibberellins or SGs. If KA13H activity is favored, steviol will be produced. From steviol, by consecutive rounds of glycosylation performed by diverse uridine-diphosphate glycosyltransferases (UGTs) located in the cytoplasm, multiple SGs are synthesized. The most abundant SGs, stevioside and rebaudioside A, are produced downstream by the activity of the highly promiscuous UGT74G1 and UGT76G1 enzymes. The stevioside and rebaudioside A accumulated are subsequently transported and stored in the vacuole. Representation adapted from Singh et al. (2017) and Libik-Konieczny et al. (2021).

The SGs content is also conditioned by other agronomic factors such as growing conditions and crop management (Díaz-Gutiérrez et al., 2020; Khiraoui et al., 2021). *S. rebaudiana* grows under a sunny climate (Hossain et al., 2017; Jarma-Orozco et al., 2020) and, although it is catalogued as a short-day plant, it has been shown that growth in a long day photoperiod favours SGs production. The optimum light intensity range for *S. rebaudiana* cultivation remains controversial (Ceunen et al., 2013a; Yoneda et al., 2017a). The effect of light on gene regulation in model plants has been widely

studied and light quality and quantity have a marked influence on primary and specialized metabolism. For example, several studies have shown that genes encoding GAs biosynthesis enzymes are controlled by light conditions (Roberts and Paul, 2006; Seo et al., 2009; Ncube et al., 2012; Vishal and Kumar, 2018; Yang et al., 2018) and in some cases, it has been shown that this results in changes of bioactive GA levels. Unfortunately, there are few studies on how light can affect SGs production or the expression of the main enzymes that regulate SGs synthesis (Singh et al., 2017).

The aim of this research is to quantify the levels of SGs in the two most used *S. rebaudiana* cultivars Morita II and Criolla and to evaluate the effect of light intensity on the production of SGs, including the analysis of the expression of three genes (*SrKA13H*, *SrUGT74G1* and *SrUGT76G1*) that encode the main enzymes of the metabolic pathway associated with the biosynthesis of SGs. We have observed a complex interplay among the levels of the expression of different enzymes and the resulting SGs proportion, in particular under different light intensities. This work will allow a better selection of elite cultivars and the growth conditions to be used in health and food industry.



## 2. Results

### 2.1. Comparison of SGs production in Morita II and Criolla cultivars of *S. rebaudiana*

We have quantified the SGs content in two broadly used cultivars of *S. rebaudiana*, Morita II and Criolla. Fig. II.2 shows the content of stevioside and rebaudioside A of both cultivars. Comparing the representative chromatograms of each variety, we found a noticeable change in the relative abundance of stevioside and rebaudioside A (Fig. II.2A and 2B). First, the Morita II cultivar showed approximately six times greater production of rebaudioside A than stevioside (Fig. II.2C). On the other hand, when analysing the contents of SGs in Criolla cultivar we observed the opposite, stevioside being the major compound and approximately three times greater than the content of rebaudioside A (Fig. II.2D). Finally, when comparing total contents of SGs in both cultivars, a marked difference was observed: the production in Morita II was higher than in Criolla. Therefore, Morita II cultivar not only



accumulates more SGs than Criolla plants but also has more rebaudioside A than stevioside (high rebaudioside A:stevioside ratio).

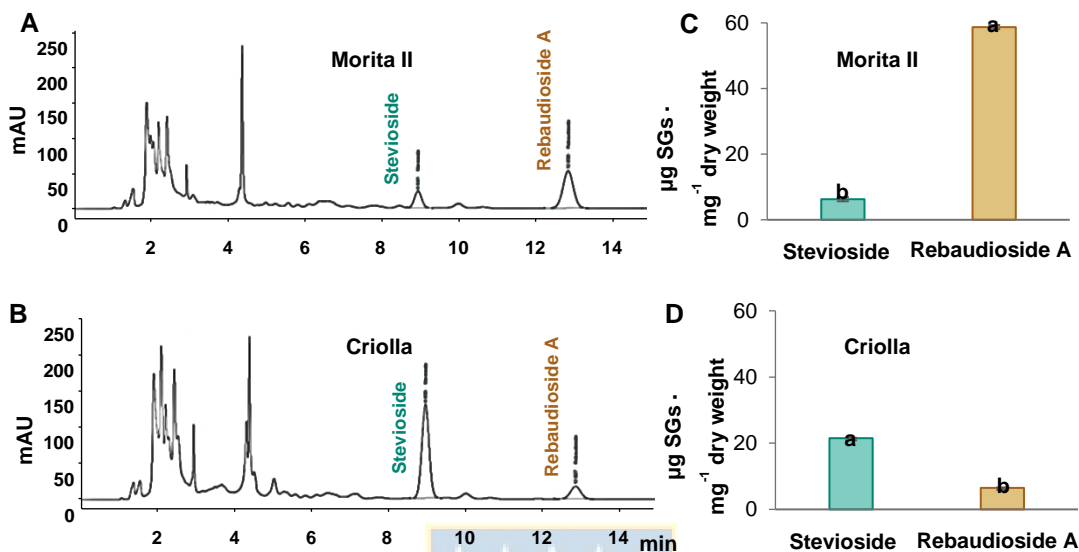
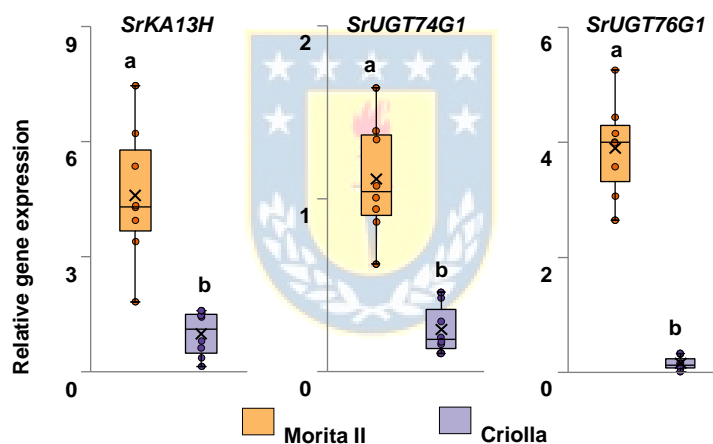

**Fig. II.2.** Levels of stevioside and rebaudioside A in extracts of leaves from *S. rebaudiana* cultivars Morita II and Criolla. Representative HPLC chromatograms (intensity of absorbance in milli-Absorbance Units - mAU) for the cultivar (A) Morita II and (B) Criolla. Contents of stevioside and rebaudioside A ( $\mu\text{g} \cdot \text{mg}^{-1}$  of dry weight) on leaves of cultivar (C) Morita II and (D) Criolla, grown for 45 days under greenhouse conditions with a light intensity of  $900 \mu\text{mol} \cdot \text{m}^{-2} \cdot \text{s}^{-1}$ . Results with the same letter are not statistically different (One Way ANOVA, Tukey,  $P < 0.05$ ,  $n = 5$ ).

## 2.2. Comparison of the gene expression of key enzymes of the SGs synthesis pathway in Morita II and Criolla cultivars of *S. rebaudiana*

We next explored the possibility that differences in SGs content between cultivars were caused by differences in the expression of genes encoding enzymes of the SGs biosynthetic pathway. *SrKA13H* is one of the most important genes in the SGs biosynthesis because it generates steviol, the starting molecule for the production of the wide diversity of SGs (Fig. II.1). On the other hand, *SrUGT74G1* and *SrUGT76G1* genes encode the most abundant enzymes in the pathway that give rise to stevioside and rebaudioside A, (Fig. 1). When comparing the relative expression of these three genes, significant higher levels of transcription in all of them were observed in leaves of Morita II than in Criolla cultivars (Fig. II.3), which correlated with the higher SGs content that was found in this

cultivar (Fig. II.2). The highest difference of gene expression was recorded for *SrKA13H* and *SrUGT76G1*. The higher contents of rebaudioside A obtained in the Morita II cultivar than in the Criolla, is not only due to a higher expression of the genes responsible for the glycosylation reactions. Rather, because both genes (*SrUGT74G1* and *SrUGT76G1*), code for promiscuous enzymes responsible for the synthesis of SGs (Fig. II.1). It is difficult to establish a correlation between a specific UGT and a specific product: some authors have verified that specificity can be relatively low by analysing UGT variants with amino acid substitutions in protein domains that affect enzyme-substrate recognition (Richman et al., 2005; Petit et al., 2019). Therefore, it has been found that there is a wide compatibility of the substrate attributed to plant glycosyltransferases.



**Fig. II.3.** Relative expression levels of the main genes regulating the metabolic pathway for the synthesis of stevioside and rebaudioside A, *SrKA13H*, *SrUGT74G1* and *SrUGT76G1*, in the *S. rebaudiana* cultivars Morita II and Criolla. Transcription levels were normalized against two reference genes. The mean is represented by an x. The different letter above each box plot indicates significant differences (One Way ANOVA, Tukey,  $P < 0.05$ ,  $n = 8$ ).

### 2.3. Effect of different light intensities on photosynthetic parameters

As the cultivar Morita II presented both higher rebaudioside A:stevioside ratio and total content of SGs, this cultivar was selected to study the effect of light intensity on the synthesis of SGs. The

morphological appearance of the plants 15 days after being differentially subjected to three light intensities is showed in the Fig. II.4A. Initially, photosynthetic parameters were evaluated to know if there is photoinhibition in different light treatments to correlate the effect of light with the synthesis of SG, avoiding photosynthetic stress conditions. We used the chlorophyll fluorescent signal to evaluate different aspects related to photosynthesis. Plants were subjected to different increasing light intensities (PAR) and curves of rapid response variable fluorescence ( $F_v$ ) were constructed (Fig. II.4B). The  $F_v$  is the difference between maximum ( $F_m$ ) and initial ( $F_o$ ) fluorescence. This gives the parameter  $F_v/F_m$ , the optimum values of which vary between 0.75 and 0.85. The  $F_v/F_m$  which represents the maximum quantum yield of PSII (photosystem II) also gives an indication of the stress level of the plants and indirectly informs about the maximum photochemical quantum yield of PS II.

From Fig. II.4C, it can be seen that *S. rebaudiana* plants grown at three light intensities (high, medium and low) have a similar  $F_v/F_m$  values. This suggested that plants in those light intensities are not under light stress. To analyze if there were differences in the photosynthetic efficiency in the different light conditions, electron transport rate (ETR) and apparent rate of photosynthesis (PS) were calculated. The ETR values of *S. rebaudiana* at different light intensity treatments (high, medium, and low) were calculated as a function of the range of actinic irradiance used. Plants grown at high and medium light intensity showed higher levels of ETR (Fig. II.4D). It was observed that *S. rebaudiana* plants grown in high light showed an  $ETR_{max}$  of 135 while the  $ETR_{max}$  of plants grown in medium light was 123 (Fig. II.4D). High photosynthetic capacity ( $ETR_{max}$ ) represents the ability to transfer more electrons at high light and thus to process more solar energy. The apparent rate of photosynthesis (PS) recorded for plants grown at high and medium light intensities showed no statistically significant difference, however, there was a difference compared to plants grown at low light intensities (Fig. II.4E). Maximum photosynthesis rate was observed in plants grown at our highest light intensities studied. As well as the highest values of electron transport rate. These results showed that among our light intensities the cultivar Morita II have higher photosynthetic activity at higher light intensities.

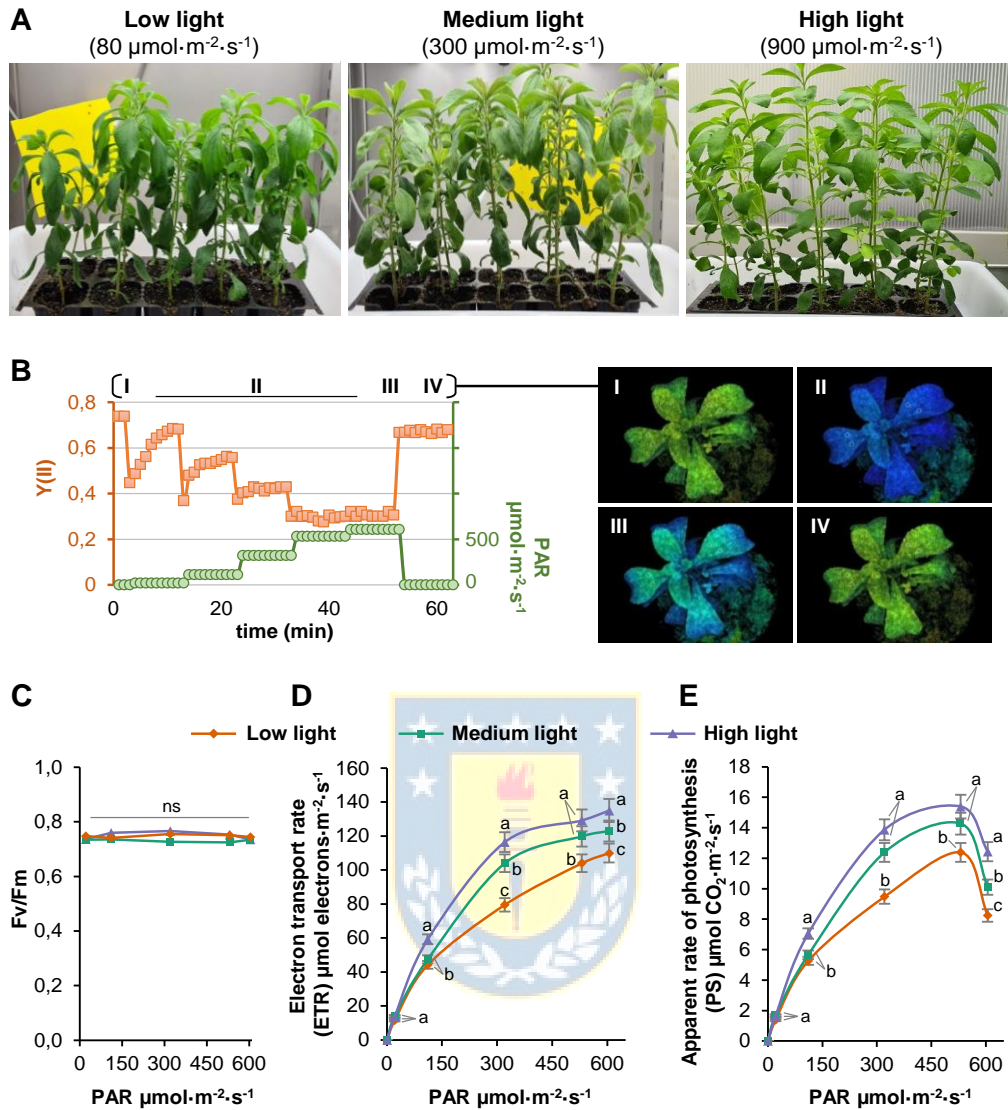

**Fig. II.4.** Photosynthetic parameters in *S. rebaudiana* plants cultivar Morita II treated with different light intensities. (A) Morphological appearance of plants 15 days after being subjected to three light intensities: (left) low light (80  $\mu\text{mol}\cdot\text{m}^{-2}\cdot\text{s}^{-1}$ ); (middle) medium light (300  $\mu\text{mol}\cdot\text{m}^{-2}\cdot\text{s}^{-1}$ ); and (right) high light intensity (900  $\mu\text{mol}\cdot\text{m}^{-2}\cdot\text{s}^{-1}$ ). (B) Typical measurement obtained from the IMAGIM-PAM chlorophyll fluorometer, (left) Representation of Quantum yield of photochemical energy conversion in PS II (Y(II)) and Pulse-Amplitude-Modulation (PAM) values during the time of the experiment. Different phases have been highlighted: I, initial pulse of actinic light; II, increased steps of actinic light; III, maximum saturation point; IV, recovery after exposure; (right) images of the plants during the different phases of the measurements. (C) Maximum quantum yield of PSII (Fv/Fm), (D) Electron transport rate (ETR) and (E) Apparent rate of photosynthesis (PS) obtained at the different light intensities. The error bars represent the standard deviation of the mean (n=5). Different letters above each bar indicate significant differences (One Way ANOVA, Tukey, P < 0.05).

#### 2.4. Effect of light intensity on SGs production in *S. rebaudiana* cultivar Morita II

As shown before, cultivar Morita II showed higher rebaudioside A content than stevioside (Fig. II.2C). We observed that the light intensity in which the plants grew for the last 15 days had an impact in the production and accumulation of SGs. Indeed, the higher the light intensity, the higher the levels of stevioside and rebaudioside A in the leaves (Fig. II.5A, B), which established a positive correlation between increasing amount of light and SGs concentration. Statistically significant differences were observed between amount of light and SGs concentration. Stevioside significantly increased from  $7.7 \mu\text{g}\cdot\text{mg}^{-1}$  of dry weight at the lowest light intensity till  $29.2 \mu\text{g}\cdot\text{mg}^{-1}$  of dry weight in the highest. Therefore, stevioside content was increased 3.8 times from the lowest to the highest light conditions. When we analysed the rebaudioside A content (Fig. II.5B), we also found the highest concentration ( $51.9 \mu\text{g}\cdot\text{mg}^{-1}$  of dry weight) at high light intensity with respect to medium and low light intensities. However, the production of rebaudioside A seems to be less light-dependent than stevioside, as no significant differences were observed for rebaudioside A content between the low and medium light intensities, reaching values of  $34.1$  and  $34.4 \mu\text{g}\cdot\text{mg}^{-1}$  of dry weight, respectively.

#### 2.5. Effect of light intensity on gene expression levels of *SrKA13H*, *SrUGT74G1* and *SrUGT76G1* in *S. rebaudiana* cultivar Morita II

We aimed to establish if the light intensity also affected the expression of the genes encoding key enzymes of stevioside and rebaudioside A biosynthesis. Therefore, we explored if the expression of *SrKA13H*, *SrUGT74G1* and *SrUGT76G1* changed in plants after 15 days under the three different light intensities (Fig 5C-E) and whether they correlated with the differences in SGs levels (Fig II.5A, B). The expression of *SrKA13H* was higher at medium and high light intensities (Fig. II.5C), with no significant differences between these two light intensities. Expression levels of *SrUGT74G1* (Fig. II.5D), were significantly increasing from the lowest to the highest light intensities: the *SrUGT74G1* gene expression at high light level was 1.8 and 1.5 times more than at low and medium light intensities, respectively.

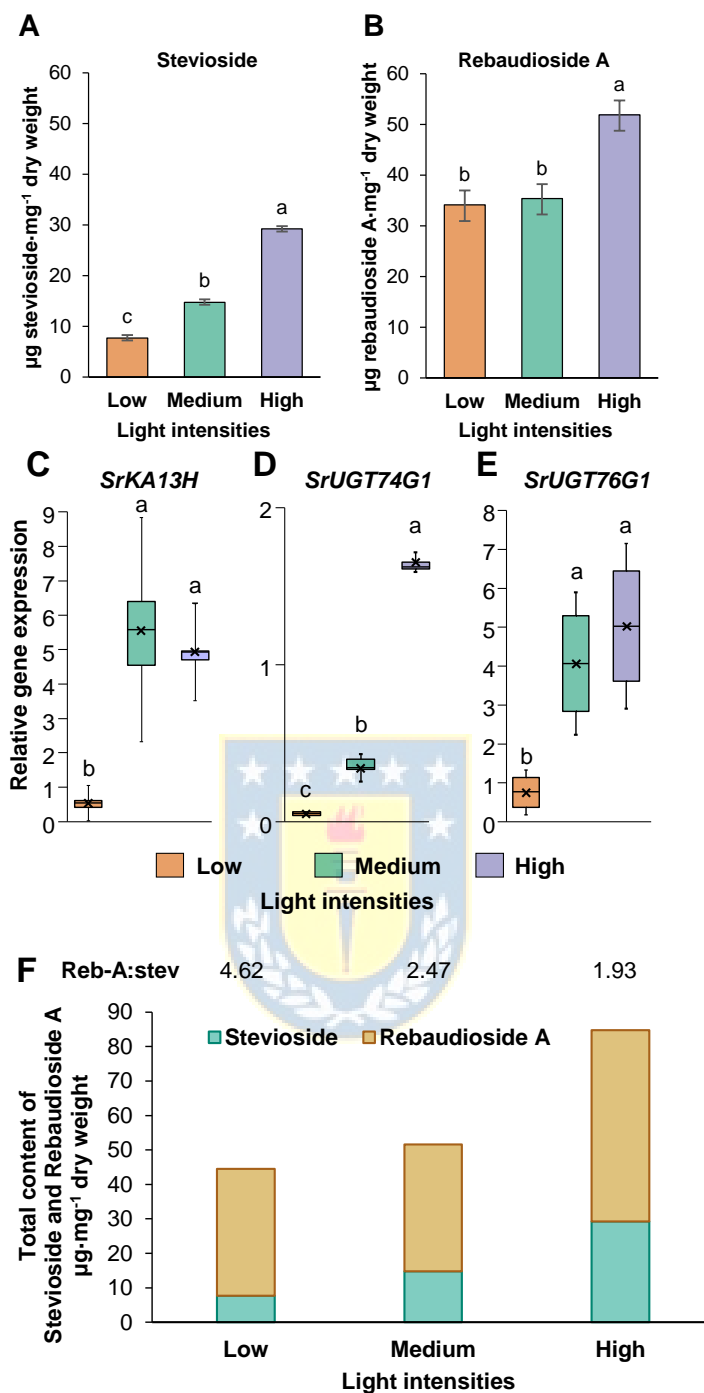

**Fig. II.5.** Effect of three light intensities on the production of stevioside and rebaudioside A and the expression of their biosynthetic enzymes in *S. rebaudiana* cultivar Morita II. Quantification of (A) stevioside and (B) rebaudioside A. Each bar represents the mean. The error bars represent the standard deviation of the mean. Different letters above each bar indicate significant differences (One Way ANOVA, Tukey,  $P < 0.05$ ,  $n=5$ ). Gene expression levels of (C) *SrKA13H*, (D) *SrUGT74G1* (E) and *SrUGT76G1* Transcription levels were normalized against two reference genes. The mean is represented by an x. The different letter above each box plot indicates significant differences (One Way ANOVA, Tukey,  $P < 0.05$ ,  $n=8$ ). (F) Sum of stevioside and rebaudioside A (data from A and B) and ratio of rebaudioside A: stevioside (on the top).

The last gene analysed, *SrUGT76G1* (Fig. II.5E), showed no statistically significant difference of expression in plants grown at medium and high light intensities, although were higher than at low intensity. In summary, *SrKA13H* and *SrUGT76G1* reaches their highest expression already at medium light intensity and only *SrUGT74G1* presented constant increase of expression with increasing amount of light.

Analyzing the correlation between SGs production (the sum of stevioside and rebaudioside A, Fig II.5F) and the expression of the genes encoding the enzymes that participate in their biosynthesis at different light intensities, it was observed that as light intensity increased, the amount of SGs also accumulated, particularly at high intensity (Fig. II.5F), correlating with the overexpression of the genes, that increased when rising light intensity (Fig. II.5C-E). This accumulation of total SGs at increasing light intensities was mainly due to the stevioside accumulation (as rebaudioside A levels are less dependent on light). Consequently the rebaudioside A:stevioside ratio (rebA:stev) was the lowest at high light (Fig. II.5F), and this might have an impact on bitterness total SGs extraction.

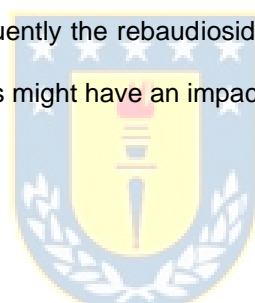

### 3. Discussion

#### 3.1. Effect of the expression of SGs biosynthetic genes on the levels of SGs in *S. rebaudiana* cultivars Morita II and Criolla

The SGs content is, at least in part, genetically determined as evidences the distinct amounts and composition of the diverse cultivars of *S. rebaudiana* (Tavarini et al., 2018). To analyse at which extent the expression of SGs biosynthetic enzymes differs among genetic backgrounds and how this can affect the SGs accumulation, we have focused on the study of SGs content on leaves of the *S. rebaudiana* cultivars Morita II and Criolla, the most known and cultivated varieties. First of all, the amount of stevioside and rebaudioside A, the SGs that contribute the most to the sweetness of *Stevia* leaves, was determined in both cultivars. In agreement to previous investigations, Morita II presents a high content of SGs, particularly rebaudioside A (Aranda-González et al., 2015; González-Chavira et al., 2018; Abdelsalam et al., 2019). Specifically in our study, compared to the Criolla

cultivar, the levels are 9.69 times higher. Importantly, the high amount of rebaudioside A in the Morita II cultivar was specific for this SG, as levels of stevioside were not as high; in fact, stevioside concentration was 3.4 times lower in the Morita II than in the Criolla cultivar.

To investigate the impact of expression of genes that encode the main enzymes that regulate the synthesis of the majority SGs in the Morita II and Criolla cultivars, we evaluated the transcription of three genes encoding different enzymes of the SGs synthesis pathway. We have selected to study the expression of *SrKA13H* (which encodes the KA13H enzyme), as the extremely important enzyme responsible for forming the structural aglycone (steviol), a starting metabolite from which SGs route diversifies (Fig. II.1). Therefore, to favor the production of SGs, steviol needs to be synthesized. In fact, it has been reported that the overexpression of *SrKA13H* can lead to accumulation of steviol (as occurs when overexpressed in *E. coli*, Wang et al., 2016; Moon et al., 2020). We also analyzed the expression of *SrUGT74G1* and *SrUGT76G1*, which encode to enzymes involved in several glycosylation steps that allow the formation of stevioside and rebaudioside A (Fig. 1). By using *in vitro* and *in vivo* assays, the promiscuous nature of UGT74G1 and UGT76G1 enzymes was established, i.e., that these enzymes displayed a broader substrate specificity, catalysing the formation of a variety of products, which brings greater complexity to the regulation of SGs metabolism (Richman et al., 2005; Wu et al., 2020). Therefore, all three enzymes (KA13H, UGT74G1 and UGT76G1) can contribute to the synthesis of both stevioside and rebaudioside A. When we compared the transcription of these genes among cultivars, all of them had higher levels of expression in the cultivar Morita II than in the Criolla. The promiscuous nature of UGT74G1 and UGT76G1 could explain that the levels of rebaudioside A and not those of stevioside were higher in Morita. Moreover, stevioside is the substrate of the UGT76G1 to generate rebaudioside A. As the highest difference of expression between the two cultivars is on the *SrUGT76G1*, this agrees with the high activity driving towards the synthesis of rebaudioside A, consequently stevioside is consumed. When *SrUGT76G1* is expressed at low levels, stevioside can be accumulated as occurs in the Criolla cultivar, resulting in higher content of stevioside than rebaudioside A, as previously described (Angelini and Tavarini, 2014).



### 3.2. Effect of light intensity on SGs production in *S. rebaudiana*

Not only genetic but also environmental and growing conditions can affect SGs composition. Among the different abiotic factors, the effect of light on *S. rebaudiana* SGs production has been addressed by different authors (Ceunen et al., 2012; Ceunen and Geuns, 2013a, 2013b; Jarma-Orozco et al., 2020; Shulgina et al., 2021; Yoneda et al., 2017a, 2017b). In contrast to what was reported in these works that address different aspects of light quantity and quality, for deciphering the effect of light intensity and no other variables in this study we have taken into consideration: (1) the possible negative effects caused by an excess light, avoiding this by selecting light intensities below the light saturation point; (2) that the development stage can influence the SG content (Ceunen and Geuns, 2013b), and for this reason the different light treatments were applied only for 15 days to cultivar Morita II, being the analysis done on plants with similar physiological and developmental stage; and (3) how different light intensities affect the gene expression of the most prominent SGs biosynthetic enzymes (*SrHA13H*, *SrUGT74G1*, *SrUTG76G1*) and its correlation with SGs composition. In the following paragraphs, these three aspects will be developed in a greater detail.

We have selected three different light intensities (from 80 to 900  $\mu\text{mol m}^{-2}\cdot\text{s}^{-1}$ ) that presented a positive correlation with an increased photosynthetic efficiency (based on the electron transport rate and the apparent rate of photosynthesis, Fig. II.4C and D respectively). We were under the 1200  $\mu\text{mol}\cdot\text{m}^{-2}\cdot\text{s}^{-1}$  of light saturation point established in *S. rebaudiana* cultivar Morita II grown under field conditions (Jarma-Orozco et al., 2020). Above this value, negative effects on photosynthetic apparatus and biomass production occur. Our conditions are clearly under this point, as even the highest light intensity treatment presents the maximum fluorescence ratio (Fig. II.4B), in consequence photosystems are not damaged. Thus, higher photosynthesis is occurring when we increase light intensity, hence also its products, such ATP and NADPH, molecules that are used in the synthesis of specialized metabolites such as SGs (Prasad et al., 2019). The KO and KA13H activity require the support of a NADPH-dependent cytochrome P450 reductase (CPR) to convert *ent*-kaurene to *ent*-kaurenoic acid and finally to steviol (Fig. II.1) (Zhou et al., 2021; Ko and Woo, 2021). By reconstructing the SGs pathway in *E. coli*, has been proved that *ent*-kaurenoic acid accumulates by increasing

NADPH levels (Moon et al., 2020). Therefore, we can speculate that activity of these NADPH-dependent enzymes will be dependent on photosynthesis. With higher photosynthesis rates, it is expected that the promoted activity of the KO-CPR-KA13H module could lead to the accumulation of steviol, that in turn can stimulate the following glycosylation reactions to produce SGs. This links with our results where SGs content increased at the same time that light was intensified (Fig. II.5F). If the plant benefits from the accumulation of SGs at high light conditions is unknown.

We must take into consideration that although the total SGs at high light recorded the major levels, the proportion of stevioside was also the highest: even though rebaudioside A levels were significantly higher at maximum light, the rebaudioside A:stevioside ratio was the lowest. This is an important aspect to consider when using SGs as natural sweeteners, due to the stevioside bitterness. The type of SGs synthesized can be related with the expression of the biosynthetic enzymes. For that reason, besides the positive effect that increase photosynthetic product can have on the SGs production, we have studied if 15 days of different light intensities affect the expression of the biosynthetic genes. Several works have observed that *SrKA13H*, *SrUGT74G1* and *SrUGT76G1* expression changes upon different environmental conditions such as salinity (Lucho et al., 2019), or under the effect of different elicitors such as salicylic acid, chitosan and hydrogen peroxide (Vazquez et al., 2019). The work of Yoneda et al. (2017b) studied the interaction of different light treatment and expression of SGs biosynthetic enzymes in *S. rebaudiana*. Although this work also performed different light intensities, the most important changes on gene expression and SGs accumulation were observed when red, far-red and end-of-day far-red light treatments were applied. The increase of SGs content by supplementing red or far-red light has been also reported by others (Ceunen et al. 2012; Shulgina et al., 2021). When Yoneda et al. (2017b) studied different light intensities (from 50 to 400  $\mu\text{mol}\cdot\text{m}^{-2}\cdot\text{s}^{-1}$ ), they did not detect changes in the expression of *SrUGT74G1* (nor in the other SGs biosynthesis-related genes *KO* and *UGT85C2*) but *SrUGT76G1* was overexpressed at 100  $\mu\text{mol}\cdot\text{m}^{-2}\cdot\text{s}^{-1}$ . Unfortunately, this work does not measure the different SGs content under different light intensities. Moreover, *S. rebaudiana* biomass was very different under the different treatments, as also occurs in other works where SGs content has been reported higher in long-day photoperiod

(Ceunen and Geuns, 2013a, 2013b). In our study, the expression of genes related to the three SGs synthesis enzymes (KA13H, UGT74G1 and UGT76G1) increased at higher light intensities. However, it cannot be stated that the amounts of stevioside and rebaudioside A produced at different light intensities evaluated depends exclusively on the greater expression of one gene with respect to the other. For example, at medium and high light intensity levels, no significant differences were observed in the expression of *SrKA13H* and *SrUGT76G1*, however a greater production of rebaudioside A was observed. This can be explained by the higher expression of the *SrUGT74G1* enzyme along the increasing light intensities that corresponds with an accumulation of stevioside, also a precursor of rebaudioside A. Therefore, to increase the levels of rebaudioside A and obtain extracts with more sweetness, it is not only necessary to increase its direct biosynthetic enzyme, but also others involved in the previous steps of the pathway.

### 3.3. Concluding remarks

The identification and characterization of *S. rebaudiana* genotypes offers value added to the specialized metabolites that are synthesized in its leaves to enhance their use in food and pharmaceutical industry. Comparing the cultivars Morita II and Criolla, it was found that Morita II overexpressed of the main enzymes of the metabolic pathway for the synthesis of SGs, resulting in accumulation of rebaudioside A. This higher levels in Morita II give this cultivar a high market value to produce sweeteners.

On the other hand, when evaluating the effect of light intensity, it was observed a significant accumulation of rebaudioside A and stevioside when light intensity increased. Importantly, a light treatment period of 15 days was enough to produce differences on SGs content, despite no phenotypic differences were observed. That can be useful to stimulate SGs production before harvesting. In this study it was shown that light plays a key role in the gene expression of three main enzymes of the metabolic pathway and stimulates the production of SGs. Differential gene expression of the enzymes impacts on the specific SG synthesized. To know the pattern and the conditions that modulate the expression of these enzymes, it will allow to generate extracts with lower levels of

stevioside (with bitter taste) and higher levels of rebaudioside A (with sweetest taste). These studies might be helpful to design a proper light management to increase SGs yield.

## 4. Experimental

### 4.1. Growth conditions to compare *S. rebaudiana* cultivars Morita II and Criolla

The *Stevia rebaudiana* (Bertoni) Bertoni (Asteraceae) cultivars Morita II and Criolla were propagated by cuttings and grown under greenhouse conditions, with long day photoperiod (16 h light, 8 h dark), light intensity of approximately  $900 \mu\text{mol}\cdot\text{m}^{-2}\cdot\text{s}^{-1}$ , relative humidity of 60% and temperature of  $22^{\circ}\text{C} \pm 1^{\circ}\text{C}$ . At 45 days, samples were taken from the third pair of leaves (counted from the top) of five plants of each cultivar. Each plant was used as a biological replica. The content of SGs and the relative expression of the genes *SrKA13H*, *SrUGT74G1* and *SrUGT76G1* were analysed.

### 4.2. Growth conditions at different light intensities of *Stevia rebaudiana* plants

Morita II plants were multiplied by cuttings as described in section 2.1 until reaching an approximate height of 14-15 cm. The experiment was performed in randomized blocks, five biological replicates were used per treatment. Rooted cuttings were transferred to three different light conditions for 15 days: high light intensity ( $900 \mu\text{mol}\cdot\text{m}^{-2}\cdot\text{s}^{-1}$ ), medium light intensity ( $300 \mu\text{mol}\cdot\text{m}^{-2}\cdot\text{s}^{-1}$ ) and low light intensity ( $80 \mu\text{mol}\cdot\text{m}^{-2}\cdot\text{s}^{-1}$ ). The different light intensities were provided by LED fluorescent tubes. These conditions were used to measure photosynthetic activity and to collect material (from the third pair of leaves of each plant) to analyse the content of SGs and the relative gene expression.

### 4.3. SGs analysis by HPLC

To quantify the levels of SGs, high performance liquid chromatography (Agilent 1200 series HPLC) was used under isocratic conditions in a Varian System (Darmstadt, Germany), consisting of a Pro Star 230 pump, a 335-diode array detector set to a wavelength of 210 nm. To detect stevioside and rebaudioside A, a Luna HILIC analytical column (250 x 4.6 mm, 5  $\mu\text{m}$  particle size, Phenomenex,

Aschaffenburg, Germany) was used. The mobile phase consisted of acetonitrile: water (85:15, v: v) adjusted to a flow rate of 1.0 ml·min<sup>-1</sup> maintained at 25°C.

Steviol glycoside standards (stevioside and rebaudioside A, obtained from Sigma Aldrich, Darmstadt, Germany) were prepared by diluting them in acetonitrile and ethanol (1:1) at a concentration of 1 mg·ml<sup>-1</sup> and determined under the conditions described above (Fig. II.6).

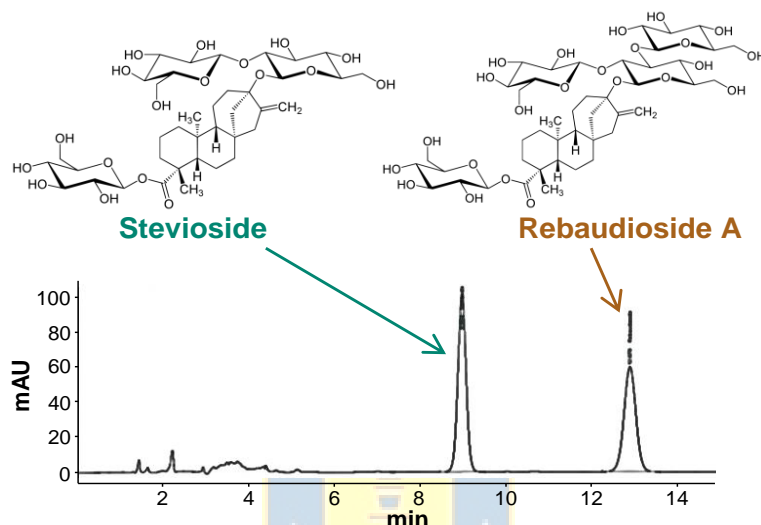

**Fig. II.6.** Chromatograms of stevioside and rebaudioside A standard solutions used for the quantification of *S. rebaudiana* leaves extracts. Intensity of absorbance in milli-Absorbance Units (mAU).

For the extraction of SGs, the procedure of Wölwer-Rieck et al. (2010) was used. After harvesting, *S. rebaudiana* leaves were freeze-dried at all experimental stages. Samples were ground using a mortar and pestle and liquid nitrogen to produce a fine powder. 12 mg were weighed and collected in a 2 ml Eppendorf tubes. Subsequently, the extraction process was carried out with a volume of 1.5 ml of ethanol and acetonitrile (1:1; v: v) in a heating block at 102°C for 30 min. The supernatant was recovered. Plant material was re-extracted using the same procedure three additional times, to then reach a final volume of 10 ml. Each extract was cooled to room temperature and centrifuged for 15 min at 12000 rpm. The SGs content was expressed in µg·mg<sup>-1</sup> of dry weight.

#### 4.4. Gene expression analysis by RT-qPCR

RNA was extracted from leaves (ca. 70 mg of fresh weight per biological replica) and purified using the Qiagen RNeasy Plant Mini Kit or the semiautomatic Maxwell kit Simply RNA (Promega). For real-time qPCR analysis, RNA (2 µg) was reverse transcribed using M-MLV reverse transcriptase (Invitrogen) or Transcription First Strand cDNA synthesis (Roche, Sweden). Reference genes used were  $\beta$ -ACTIN and *EF1 $\alpha$* . The list of primers used for real-time PCR amplification, efficiency and the resulting product size are specified in Table 1. Quantification of gene expression was performed as indicated by Gan et al. 2016.

**Table.II.1.** List of primers used for real-time PCR amplification, indicating the resulting amplicon size and primer efficiency ( $E = 10^{(-1/\text{slope})}$ ).

Sequence of primers (5' to 3')	GenBank Accession number	Amplicon size bp	Efficiency	Reference
<i>SrKA13H</i> Fw: CCGACTCCATTACCTTTGT Rv: ACTTGATGGGGATGAAGACG	DQ398871.3	206	1.94	Kim et al. (2015)
<i>UGT74G1</i> Fw: TGTTTCGGTTCCTGGATTC Rv: GAAGACCCAACGTGCTTGAT	AY345982.1	139	2	this work
<i>UGT76G1</i> Fw: AGCGTTTGTGAAGGTGTTCC Rv: CCCACCCATTTTCCAAATAC	AY345974.1	115	1.91	this work
$\beta$ -Actin Fw: AGCAACTGGGATGACATGGAA Rv: GGAGCGACACGAAGTTCATTG	AF548026.1	65	1.87	Lucho et al. (2018)
<i>EF1<math>\alpha</math></i> Fw: ATGCTCTTCTTGCTTTCACTC Rv: GATTTCTTCATACCTCGCCT	AY157315.1	104	2	Lucho et al. (2018)

#### 4.5. Photosynthetic activity

Photosynthetic activity was measured as described (Morelli et al 2021). Briefly, plants grown at different light intensities (section 4.2) were put in darkness for 30 min to allow the full relaxation of photosystems. Fluorescent signals were measured through light responses with a chlorophyll fluorimeter (IMAGIM-PAM M-series, Heinz Walz, Effeltrich, Germany). Subsequently, the light intensity was increased in six steps of actinic light (E: 0, 21, 111, 321, 531, and 605 µmol photons·m<sup>-2</sup>·s<sup>-1</sup>).

$2 \cdot s^{-1}$ ) and curves were constructed in rapid response to the variation of light intensity from the quantum yield of photochemical energy conversion in PS II ( $Y(II)$ ) measured values.

According to Murchie and Lawson (2013), the minimum value for chlorophyll fluorescence ( $F_o$ ) in the dark-adapted state was determined by applying a weak pulse of modulated light, and the maximum fluorescence ( $F_m$ ) was induced by a short pulse of saturating light. The fluorescence signals were followed until they reached a steady state ( $F_s$ ). With these values, we could calculate the maximum quantum yield of PSII ( $F_v/F_m$ ), following the formula  $F_v/F_m = (F_m - F_o)/F_m$ . Once data from fluorimeter was obtained, the apparent rate of photosynthesis (PS) and the electron transport rate (ETR) were calculated, based on the criteria described by Zhen and Bugbee (2020). The light response was characterized by correlation between maximum photosynthetic rate (Net P) vs photosynthetically active radiation (PAR) using MS Excel Solver. The model of Platt et al. (1980) was used and the fit was considered acceptable in all cases for  $r > 0.98$ .

#### 4.6. Statistical analysis

SPSS (Version 20.0 for Windows, SPSS Inc.) was used in the data's statistical processing. Statistical tests performed, sample size, and P values are indicated in each table and figure legend.

#### Declaration of competing interest

The authors declare that they have no known competing financial interests or personal relationships that could have appeared to influence the work reported in this paper.

#### Acknowledgements

The authors would like to thank ANID for the grant that allowed a research stay in the laboratory at Centre for Research in Agricultural Genomics (CRAG), CSIC-IRTA-UAB-UB in Barcelona, Spain. We also want to acknowledge the technical support of Rosa Rodriguez Goberna (CRAG) in the HPLC analyses.

Funding: This work was supported by the European Commission [H2020-MSCA-IF-2017, grant number 79747] to JM-R; research in CRAG was supported by the Spanish MINECO-FEDER [grant number BIO2017-85316-R] and AGAUR [grant number 2017-SGR1211 and Xarba] to JFM-G; the support of MINECO for the "Centro de Excelencia Severo Ochoa 2016-2019" [grant number SEV-2015-0533]; and by the CERCA Program of the Generalitat de Catalunya.

## References

- Abd ElHamid, R., Abd ElTawab, F., Abdel Razik, A., Allam, A., ELDoliefy, A., 2018. Micropropagation and start codon targeted characterization of four *Stevia* cultivars in Egypt. *AJS*. 26(2): 635 – 645. <https://doi.org/10.21608/AJS.2018.15968AJS>
- Abdelsalam, N.R., Botros, W.A., Khaled, A.E., Ghonema, M.A., Hussein, S.G., Ali, H.M., Elshikh, M.S., 2019. Comparison of uridine diphosphate-glycosyltransferase UGT76G1 genes from some varieties of *Stevia rebaudiana* Bertoni. *Sci Rep*. 9 (1):8559. <https://doi.org/10.1038/s41598-019-44989-4>
- Ahmed, S., Mukta, S., 2017. Review on *Stevia rebaudiana* as a non-caloric natural sweetener producing plant. *J. Sylhet Agril. Univ*. 4 (1):15-25. ISSN: 2308-1597
- Angelini, L.G. Tavarini, S., 2014. Crop productivity, steviol glycoside yield, nutrient concentration and uptake of *Stevia rebaudiana* Bert. under Mediterranean field conditions. *Commun Soil Sci Plant Anal*. 45(19): 2577-2592. <https://doi.org/10.1080/00103624.2014.919313>
- Aranda-González, I., Moguel-Ordoñez, Y., Betancur-Ancona, D., 2015. Determination of rebaudioside A and Stevioside in leaves of *S. rebaudiana* Bertoni grown in México by a validated HPLC method. *AJAC*. 6(11), 878. <https://doi.org/10.4236/ajac.2015.611083>
- Arumugam, B., Subramaniam, A., Alagaraj, P., 2020. *Stevia* as a Natural sweetener: A Review. *Cardiovascular & Hematological Agents in Medicinal Chemistry. Cardiovasc Hematol Agents Med Chem*. 18 (2):94-103. <https://doi.org/10.2174/1871525718666200207105436>
- Brandle, J., Telmer, P., 2007. Steviol glycoside biosynthesis. *Phytochemistry* 68 (14):1855-1863. <https://doi.org/10.1016/j.phytochem.2007.02.010>
- Ceunen, S., Geuns J.M.C, 2013a. Steviol glycosides: chemical diversity, metabolism, and function. *J. Nat. Prod*. 28;76 (6):1201-28. <https://10.1021/np400203b>
- Ceunen, S., Geuns, J.M.C., 2013b. Spatio-temporal variation of the diterpene steviol in *Stevia rebaudiana* grown under different photoperiods. *Phytochemistry* 89:32-38. <https://doi.org/10.1016/j.phytochem.2013.01.007>



- Ceunen, S., Werbrouck, S., Geuns, J.-M., 2012. Stimulation of steviol glycoside accumulation in *Stevia rebaudiana* by red LED light. *J. Plant Physiol.* 169 (7):749-752. <https://doi.org/10.1016/j.jplph.2012.01.006>
- Dacome, A.S., Da Silva, C.C., Da Costa, C.E., Fontana, J.D., Adelman J, Da Costa S.C., 2005. Sweet diterpenic glycosides balance of a new cultivar of *Stevia rebaudiana* (Bert.) Bertoni: Isolation and quantitative distribution by chromatographic, spectroscopic, and electrophoretic methods. *Process Biochem.* 40 (11):3587-3594. <https://doi.org/10.1016/j.procbio.2005.03.035>
- Dasgupta, A., Chowdhury, N., De R.-K., 2020. Metabolic pathway engineering: Perspectives and applications. *Comput Methods Programs Biomed.* 192:105436. <https://doi.org/10.1016/j.cmpb.2020.105436>
- Díaz-Gutiérrez, C., Hurtado, A., Ortiz, A., Poschenrieder, C., Arroyave, C., & Peláez, C., 2020. Increase in steviol glycosides production from *Stevia rebaudiana* Bertoni under organo-mineral fertilization. *Ind Crops Prod.* 147, 112220. <https://doi.org/10.1016/j.indcrop.2020.112220>
- Gan, X., Hay, A., Kwantes, M., Haberer, G., Hallab, A., Ioio, R.-D., Hofhuis, H., Pieper, B., Cartolano, M., Neumann, U., 2016. The *Cardamine hirsuta* genome offers insight into the evolution of morphological diversity. *Nat. Plants.* 2 (11):1-7. <https://doi.org/10.1038/nplants.2016.167>
- Gantait, S., Das, A., Banerjee, J., 2018. Geographical distribution, botanical description and self-incompatibility mechanism of genus *Stevia*. *Sugar Tech.* 20 (1):1-10. <https://doi.org/10.1007/s12355-017-0563-1>
- Gold, N.-D., Fossati, E., Hansen, C.-C., DiFalco, M., Douchin, V., Martin, V.-J., 2018. A combinatorial approach to study cytochrome P450 enzymes for de novo production of steviol glucosides in baker's yeast. *ACS Synth. Biol.* 7 (12):2918-2929. <https://doi.org/10.1021/acssynbio.8b00470>
- González-Chavira, M.-M., Estefanía-Ojeda, S., Díaz-Huacuz, S.R., Pons-Hernández, J.-L., Guevara-González, R.-G., Guzmán-Maldonado, S.-H., 2018. Cambios en el contenido de compuestos fenólicos, esteviosidos y nivel de metilación en *Stevia rebaudiana* elicitada. *Rev. Mexicana cienc. agric.* 9 (7):1435-1446. <https://doi.org/10.29312/remexca.v9i7.1314>

- Hossain, M., Islam, M., Islam, M., Akhtar, S., 2017. Cultivation and uses of stevia (*Stevia rebaudiana* Bertoni): A review. *Afr. J. Food Agric. Nutr. Dev.* 17 (4):12745-12757. <https://doi.org/10.18697/ajfand.80.16595>
- Jarma-Orozco A., Combatt-Caballero E., Jaraba-Navas J., 2020. Growth and development of *Stevia rebaudiana* Bert., in high and low levels of radiation. *Curr. Plant Biol.* 100144. <https://doi.org/10.1016/j.cpb.2020.100144>
- Khiraoui, A., Bakha, M., Boulli, A., Hasib, A., Al Faiz, C., 2021. The productivity of *Stevia rebaudiana* (Bertoni) on dry leaves and steviol glycosides of four varieties grown in six regions of Morocco. *Biocatal. Agric. Biotechnol.* 37, 102151. <https://doi.org/10.1016/j.bcab.2021.102151>
- Kim M.J., Jin J., Zheng J., Wong L., Chua N.-H., Jang I.-C., 2015. Comparative Transcriptomics Unravel Biochemical Specialization of Leaf Tissues of Stevia for Diterpenoid Production. *Plant Physiol.* 169(4):2462- <https://doi.org/10.1104/pp.15.01353>
- Kim, M.-J., Zheng, J., Liao, M.-H., Jang, I.-C., 2019. Overexpression of *StUGT76G1* in Stevia alters major steviol glycosides composition towards improved quality. *Plant Biotechnol. J.* 17: 1037-1047. <https://doi.org/10.1111/pbi.13035>
- Ko, S.-C., Woo, H.M., 2020. Biosynthesis of the Calorie-Free Sweetener Precursor ent-Kaurenoic Acid from CO<sub>2</sub> Using Engineered Cyanobacteria. *ACS Synth. Biol.* 9 (11): 2979-2985. <https://doi.org/10.1021/acssynbio.0c00523>
- Kumar, H., Kaul, K., Bajpai-Gupta, S., Kaul, V.-K., Kumar, S., 2012. A comprehensive analysis of fifteen genes of steviol glycosides biosynthesis pathway in *Stevia rebaudiana* (Bertoni). *Gene* 492 (1):276-284. <https://doi.org/10.1016/j.gene.2011.10.015>
- Kurek, J.-M., Krejpcio, Z., 2019. The functional and health-promoting properties of *Stevia rebaudiana* Bertoni and its glycosides with special focus on the antidiabetic potential—A review. *J. Funct. Foods.* 61, 103465. <https://doi.org/10.1016/j.jff.2019.103465>
- Moon, J. H., Lee, K., Lee, J. H., Lee, P. C., 2020. Redesign and reconstruction of a steviol-biosynthetic pathway for enhanced production of steviol in *Escherichia coli*. *Microb. Cell Factories.* 19 (1):1-12. <https://doi.org/10.1186/s12934-020-1291-x>

- Lee, S.-G., Salomon, E., Yu, O., Jez, J.-M., 2019. Molecular basis for branched steviol glucoside biosynthesis. PNAS. 116 (26):13131-13136. <https://doi.org/10.1073/pnas.1902104116>
- Lemus-Mondaca, R., Vega-Gálvez, A., Zura-Bravo, L., Ah-Hen, K., 2012. *Stevia rebaudiana* Bertoni, source of a high-potency natural sweetener: A comprehensive review on the biochemical, nutritional and functional aspects. Food Chem. 132 (3):1121-1132. <https://doi.org/10.1016/j.foodchem.2011.11.140>
- Li, Y., Zhu, W., Cai, J., Liu, W., Akihisa, T., Li, W., Kikuchi, T., Xu, J., Feng, F., Zhang, J., 2021. The role of metabolites of steviol glycosides and their glucosylated derivatives against diabetes-related metabolic disorders. Food Funct. 12 (18):8248-8259. <https://doi.org/10.1039/D1FO01370J>
- Libik-Konieczny, M., Capecka, E., Tuleja, M., Konieczny, R., 2021. Synthesis and production of steviol glycosides: recent research trends and perspectives. Appl. Microbiol. Biotechnol. 105 (10):3883-3900 <https://doi.org/10.1007/s00253-021-11306-x>
- Lucho S.R., do Amaral M.N., Benitez L.C., Milech C., Kleinowski A.M., Bianchi V.J., Braga E.J.B., 2018. Validation of reference genes for RT-qPCR studies in *Stevia rebaudiana* in response to elicitor agents. Physiol. Mol. Biol. Plants 24 (5):767-779. <https://doi.org/10.1007/s12298-018-0583-7>
- Lucho, S.-R., do Amaral. M.-N., Auler, P.-A., Bianchi, V.-J, Ferrer, M.-Á., Calderón, A.-A., Braga, E.-J.-B., 2019. Salt Stress-Induced Changes in *In Vitro* Cultured *Stevia rebaudiana* Bertoni: Effect on Metabolite Contents, Antioxidant Capacity and Expression of Steviol Glycosides-Related Biosynthetic Genes. J. Plant Growth Regul. 38 (4):1341-1353. <https://doi.org/10.1007/s11240-021-02059-6>
- Madan, S., Ahmad, S., Singh, G., Kohli, K., Kumar, Y., Singh, R., Garg, M., 2010. *Stevia rebaudiana* (Bert.) Bertoni - a review. Indian J Nat Prod Resour. 1 (3): 267-286. <http://nopr.niscair.res.in/handle/123456789/10287>

- Mizutani, K., 2002. Use of *Stevia rebaudiana* sweeteners in Japan. p. 178-195 (No. COLECCION GENERAL/583.55 S848s). In: *Stevia: the genus Stevia*. London, GB: Taylor & Francis, 2002. ISBN 9780367396602
- Morelli, L., Paulišić, S., Qin, W., Iglesias-Sánchez, A., Roig-Villanova, I., Florez-Sarasa, I., Rodriguez-Concepcion, M., Martinez-Garcia, J.-F., 2021. Light signals generated by vegetation shade facilitate acclimation to low light in shade-avoider plants. *Plant Physiol.* 186 (4):2137–2151. <https://doi.org/10.1101/2020.09.14.296632>
- Murchie, E.-H., Lawson, T., 2013. Chlorophyll fluorescence analysis: A guide to good practice and understanding some new applications. *J. Exp. Bot.* 64 (13): 3983-3998. <https://doi.org/10.1093/jxb/ert208>
- Ncube, B., Finnie, J., Van Staden, J., 2012. Quality from the field: the impact of environmental factors as quality determinants in medicinal plants. *S. Afr. J. Bot.* 82:11-20. <https://doi.org/10.1016/j.sajb.2012.05.009>
- Rout, P., Rodríguez-Garay, B., Barranco-Guzmán, A.-M., Gómez-Entzin, V., Rincón-Hernández, M., 2019. Abiotic Stress Impact and Tolerance of Natural Sweetener Plant *Stevia*. In: *Handbook of Plant and Crop Stress*, Fourth Edition (pp. 637-662). CRC Press ISBN 9781351104609
- Petit, E., Jacques, A., Daydé, J., Vallejo, V., Berger, M., 2019. UGT76G1 polymorphism in *Stevia rebaudiana*: New variants for steviol glycosides conjugation. *Plant Physiol. Biochem.* 135:563-569. <https://doi.org/10.1016/j.plaphy.2018.11.002>
- Petit, E., Berger, M., Camborde, L., Vallejo, V., Daydé, J., Jacques, A., 2020. Development of screening methods for functional characterization of UGTs from *Stevia rebaudiana*. *Sci. Rep.* 10 (1):1-10. <https://doi.org/10.1038/s41598-020-71746-9>
- Platt, T., Gallegos, C. L., 1980. Modelling primary production. In: Falkowski P.G. (eds) *Primary Productivity in the Sea*. Environmental Science Research, vol 19. pp. 339-362. Springer, Boston, MA. [https://doi.org/10.1007/978-1-4684-3890-1\\_19](https://doi.org/10.1007/978-1-4684-3890-1_19)
- Richman, A., Swanson, A., Humphrey, T., Chapman, R., McGarvey, B., Pocs, R., Brandle, J., 2005. Functional genomics uncovers three glucosyltransferases involved in the synthesis of the

- major sweet glucosides of *Stevia rebaudiana*. Plant J. 41(1): 56-67. <https://doi.org/10.1111/j.1365-313X.2004.02275.x>.
- Roberts, M.-R., Paul, N.-D., 2006. Seduced by the dark side: integrating molecular and ecological perspectives on the influence of light on plant defense against pests and pathogens. New Phytol. 170 (4):677-699. <https://doi.org/10.1111/j.1469-8137.2006.01707.x>
- Seo, M., Nambara. E., Choi. G., Yamaguchi. S., 2009. Interaction of light and hormone signals in germinating seeds. Plant Mol. Biol. 69 (4):463. <https://doi.org/10.1007/s11103-008-9429-y>
- Singh, G., Pal, P., Masand, M., Seth, R., Kumar, A., Singh, S., Sharma, R.-K., 2020. Comparative transcriptome analysis revealed gamma-irradiation mediated disruption of floral integrator gene (s) leading to prolonged vegetative phase in *Stevia rebaudiana* Bertoni. Plant Physiol. Biochem. 148:90-102. <https://doi.org/10.1016/j.plaphy.2020.01.004>
- Singh, G., Singh, G., Singh, P., Parmar, R., Paul, N., Vashist, R., Swarnkar, M.-K., Kumar, A., Singh, S., Singh, A.-K., 2017. Molecular dissection of transcriptional reprogramming of steviol glycosides synthesis in leaf tissue during developmental phase transitions in *Stevia rebaudiana* Bert. Sci. Rep. 7 (1):1-13. <https://doi.org/10.1038/s41598-017-12025-y>
- Shulgina, A.A., Kalashnikova, E.A., Tarakanov, I.G., Kirakosyan, R.N., Cherednichenko, M.Y., Polivanova, O.B., Baranova, E.N., Khaliluev, M.R., 2021. Influence of Light Conditions and Medium Composition on Morphophysiological Characteristics of *Stevia rebaudiana* Bertoni In Vitro and In Vivo. Horticulturae 7, 195. <https://doi.org/10.3390/horticulturae7070195>
- Tavarini, S., Passera, B. and Angelini, L. G., 2018. CHAPTER 1: Crop and Steviol Glycoside Improvement in Stevia by Breeding. Steviol Glycosides: Cultivation, Processing, Analysis and Applications in Food, pp. 1-31. In: Food Chemistry, Function and Analysis. The Royal Society of Chemistry 2019. <https://doi.org/10.1039/9781788010559-00001>
- Thiyagarajan, M., Venkatachalam, P., 2012. Large scale *in vitro* propagation of *Stevia rebaudiana* (Bert) for commercial application: Pharmaceutically important and antidiabetic medicinal herb. Ind Crops Prod. 37 (1):111-117. <https://doi.org/10.1016/j.indcrop.2011.10.037>

- Totté, N., Ende, W.-V.-D., Van Damme, E.-J., Compernelle, F., Baboeuf, I., Geuns, J. M., 2003. Cloning and heterologous expression of early genes in gibberellin and steviol biosynthesis via the methylerythritol phosphate pathway in *Stevia rebaudiana*. *Can J Bot.* 81 (5): 517-522. <https://doi.org/10.1139/b03-032>
- Vazquez-Hernandez, C., Feregrino-Perez, A.-A., Perez-Ramirez, I., Ocampo-Velazquez, R.-V., Rico-García, E., Torres-Pacheco, I., Guevara-Gonzalez, R.-G., 2019. Controlled elicitation increases steviol glycosides (SGs) content and gene expression-associated to biosynthesis of SGs in *Stevia rebaudiana* B. cv. Morita II. *Ind Crops Prod.* 139:111479. <https://doi.org/10.1016/j.indcrop.2019.111479>
- Vishal, B., Kumar, P.-P., 2018. Regulation of seed germination and abiotic stresses by gibberellins and abscisic acid. *Front. Plant Sci.* 9:838. <https://doi.org/10.3389/fpls.2018.00838>
- Wang, J., Li, S., Xiong, Z., Wang, Y., 2016. Pathway mining-based integration of critical enzyme parts for de novo biosynthesis of steviol glycosides sweetener in *Escherichia coli*. *Cell Res.* 26 (2): 258-261. <https://doi.org/10.1038/cr.2015.111>
- Wang, J., Zhao, H., Wang, Y., Lau, H., Zhou, W., Chen, C., Tan, S., 2020. A review of stevia as a potential healthcare product: Up-to-date functional characteristics, administrative standards and engineering techniques. *Trends Food Sci Technol.* 103:264-281. <https://doi.org/10.1016/j.tifs.2020.07.023>
- Wölwer-Rieck, U., 2018. Analysis of Steviol Glycosides. Chapter 4. pp. 84-112. In. *Steviol Glycosides: Cultivation, Processing, Analysis and Applications in Food.* (Wölwer-Rieck U ed). Food Chemistry, Function and Analysis. Vol 7. The Royal Society of Chemistry, United Kingdom, Croydon, CRO4YY, UK. <https://doi.org/10.1039/9781788010559-00084>
- Wölwer-Rieck, U., Lankes, C., Wawrzun, A., Wüst, M., 2010. Improved HPLC method for the evaluation of the major steviol glycosides in leaves of *Stevia rebaudiana*. *Eur. Food Res. Technol.* 231 (4):581-588. <https://doi.org/10.1007/s00217-010-1309-4>
- Wu, Q., La Hovary, C., Chen, H.-Y., Li, X., Eng, H., Vallejo, V., Qu, R., Dewey, R.-E., 2020. An efficient *stevia rebaudiana* transformation system and *in vitro* enzyme assays reveal novel

- insights into UGT76G1 function. *Sci. Rep.* 10 (1):1-14. <https://doi.org/10.1038/s41598-020-60776-y>
- Xu, X., Yuan, H., Yu, X., Huang, S., Sun, Y., Zhang, T., Liu, Q., Tong, H., Zhang, Y., Wang, Y., 2021. The chromosome-level *Stevia* genome provides insights into steviol glycoside biosynthesis. *Hortic. Res.* 8 (1):1-10. <https://doi.org/10.1038/s41438-021-00565-4>
- Yadav, A.-K., Singh, S., Dhyani, D., Ahuja, P.-S., 2011. A review on the improvement of stevia [*Stevia rebaudiana* (Bertoni)]. *Can. J. Plant Sci.* 91 (1):1-27. <https://doi.org/10.4141/cjps10086>
- Yang, L., Wen, K.-S., Ruan, X., Zhao, Y.-X., Wei, F., Wang, Q., 2018. Response of plant secondary metabolites to environmental factors. *Molecules* 23 (4):762. <https://doi.org/10.3390/molecules23040762>
- Yang, Y.-J., Zhang, S.-B., Wang, J.-H., Huang, W., 2020. The decline in photosynthetic rate upon transfer from high to low light is linked to the slow kinetics of chloroplast ATP synthase in *Bletilla striata*. *Photosynth. Res.* 1-9. <https://doi.org/10.1007/s11120-020-00725-y>
- Yoneda, Y., Nakashima, H., Miyasaka, J., Ohdoi, K., Shimizu, H., 2017a. Impact of blue, red, and far-red light treatments on gene expression and steviol glycoside accumulation in *Stevia rebaudiana*. *Phytochemistry* 137:57-65. <https://doi.org/10.1016/j.phytochem.2017.02.002>
- Yoneda, Y., Shimizu, H., Nakashima, H., Miyasaka, J., Ohdoi, K., 2017b. Effects of light intensity and photoperiod on improving steviol glycosides content in *Stevia rebaudiana* (Bertoni) Bertoni while conserving light energy consumption. *J. Appl. Res. Med. Aromat. Plants* 7:64-73. <https://doi.org/10.1016/j.jarmap.2017.06.001>
- Zhang, C., Hong, K., 2020. Production of terpenoids by synthetic biology approaches. *Front. Bioeng. Biotechnol.* 8:347. <https://doi.org/10.3389/fbioe.2020.00347>
- Zhen, S., Bugbee, B., 2020. Far-red photons have equivalent efficiency to traditional photosynthetic photons: Implications for redefining photosynthetically active radiation. *Plant Cell Environ.* 1259–1272. <https://doi.org/10.1111/pce.13730>

- Zhong, Z., He, B., Li, J., Li, Y.-X., 2020. Challenges and advances in genome mining of ribosomally synthesized and post-translationally modified peptides (RiPPs). *Synth. Syst. Biotechnol.* 5 (3):155-172. <https://doi.org/10.1016/j.synbio.2020.06.002>
- Zhou, X., Gong, M., Lv, X., Liu, Y., Li, J., Du, G., Liu, L. 2021. Metabolic engineering for the synthesis of steviol glycosides: current status and future prospects. *Appl. Microbiol. Biotechnol.* 1-15. <https://doi.org/10.1007/s00253-021-11419-3>





### III. CAPÍTULO II. Physiological and metabolic changes associated to the *in vitro* - *ex vitro* transition in *Stevia rebaudiana* cv. Morita II.

Article send to PPB

Journal Cover

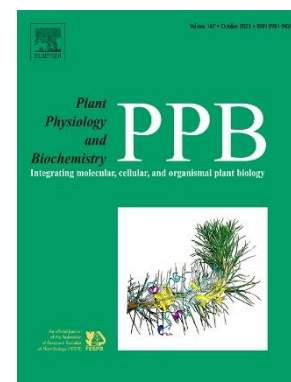

ISSN: 0981-9428; Cite Score 6.6; Impact Factor 4.27

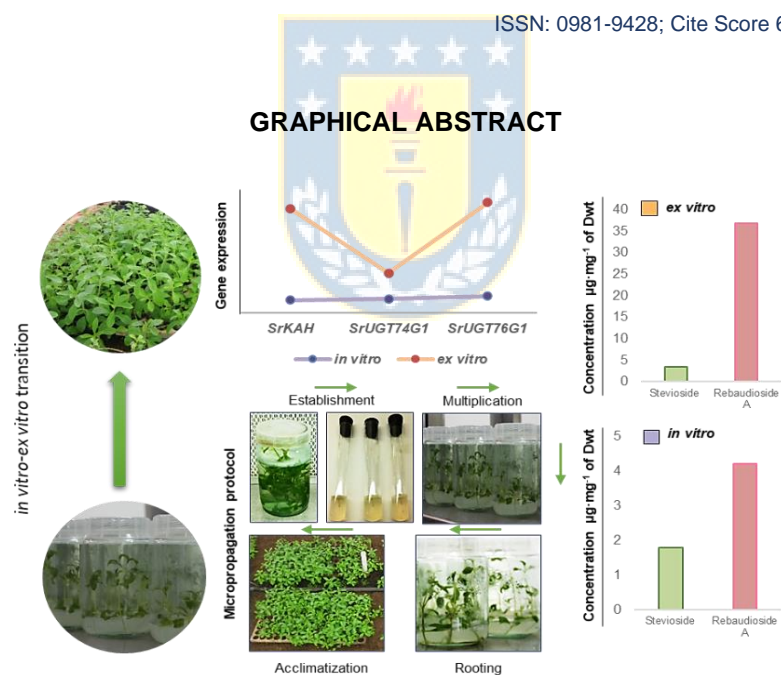

Significantly increased transcriptional levels of the steviol glycoside (SGs) biosynthetic enzymes (*SrKA13H*, *SrUGT74G1*, *SrUGT76G1*) and the production of SGs were observed in *S. rebaudiana* plants (cv. Morita II) when evaluated from mixotrophic (*in vitro*) to photoautotrophic (*ex vitro* acclimatization) transition.

**Physiological and metabolic changes associated to the *in vitro* - *ex vitro* transition in *Stevia rebaudiana* cv. Morita II.**

Karel Vives Hernández<sup>a\*</sup>, Martha Hernandez de la Torre<sup>b</sup>, José Becerra Allende<sup>a</sup>, Darcy Ríos Leal<sup>b</sup>,  
Claudia Pérez Manríquez<sup>a</sup>.

<sup>a</sup> Faculty of Natural Sciences and Oceanography. Universidad de Concepción, Victoria 631, Barrio Universitario, Casilla 160-Correo 3, Concepción, Chile.

<sup>b</sup> Faculty of Forestry Sciences and Biotechnology Center. Universidad de Concepción, Victoria 631, Barrio Universitario, Casilla 160-Correo 3, Concepción, Chile.

\* Corresponding author. Faculty of Natural Sciences and Oceanography. Universidad de Concepción, Victoria 631, Barrio Universitario, Casilla 160-Correo 3, Concepción, Chile, Tel.: +56 9 6775 7281

E-mail address: [kvives@udec.cl](mailto:kvives@udec.cl)



**ORCID number**

Karel Vives Hernández (<https://orcid.org/0000-0001-7518-8527>), Martha Hernández de la Torre (<https://orcid.org/0000-0001-8191-3597>), José Becerra Allende (<https://orcid.org/0000-0002-1444-1814>), Darcy Ríos (<https://orcid.org/0000-0001-7913-800X>) and Claudia Pérez Manríquez (0000-0002-8562-3842).

**Highlights**

- The effect of growth regulators was evaluated during the multiplication and *in vitro* rooting of *Stevia rebaudiana* plants cultivar Morita II.
- Plants adapted *ex vitro* in peat substrate with zeolite reached the highest physiological traits.
- Steviol glycoside levels and biosynthetic genes of *Stevia rebaudiana* were studied from *in vitro* to *ex vitro* transition.
- The expression of biosynthetic genes and the content of stevioside and rebaudioside A were significantly increased under photoautotrophic conditions.

## Abstract

Glycosylated diterpenes with sweetening properties are synthesized in *Stevia rebaudiana* (Bertoni) Bertoni (Asteracea) leaves. Stevioside and rebaudioside A are the most coveted in the food industry due to their organoleptic properties. The stevioside has an unwanted bitterness and the rebaudioside A has a higher sweetening potential. The adequate selection of environmental conditions that allow obtaining richer and less bitter steviol glycosides extracts is still a challenge. A micropropagation protocol was established to understand how the physiological and metabolic changes are modulated during the transition from *in vitro* to *ex vitro* conditions of *S. rebaudiana* cv. Morita II. The effect of growth regulators such as 6-benzyl amino purine (BAP); indole butyric acid (IBA) and indole acetic acid (IAA) was evaluated in each phase (*in vitro*, *ex vitro*). The effect of six different substrates mix was evaluated during the acclimatization phase. The mix of peat plus zeolite benefited all the physiological traits evaluated. The production of stevioside and rebaudioside A, as well as the gene expression levels of *SrKHA13*, *SrUGT74G1*, and *SrUGT76G1*, were significantly higher in cultivated seedlings on peat plus zeolite substrate mix, 30 days after acclimatization, compared to plants coming from *in vitro* rooting. A significant change was noticed among the physiological and morphological traits, the levels of relative gene transcription (*SrKHA13*, *SrUGT74G1*, *SrUGT76G1*) and the production of stevioside and rebaudioside A in the cultivar Morita II due to the transition process from *in vitro* to *ex vitro* conditions.

**Keywords:** *Stevia rebaudiana*; steviol glycosides; stevioside; rebaudioside A; gene expression; *SrKA13H*; *SrUGT74G1*; *SrUGT76G1*.

## 1. Introduction

*Stevia rebaudiana* (Bertoni) Bertoni (Asteraceae) has aroused great interest in the research field as well as the food industry. This plant has a group of specific metabolites called steviol glycosides (SGs) with high sweetening power which are synthesized in its leaves (Philippe et al., 2014). At least 30 different SGs have been described in the literature (Ceunen et al., 2013a), which can constitute 4 to 20% of the dry weight of the leaves (Khiraoui et al., 2021). Stevioside (4-13% of the dry weight of the leaves) and rebaudioside A (2-4%) are the most abundant compounds and main responsible for sweetness among all the SGs of *S. rebaudiana*. Improvements to the stevia propagation techniques to obtain high yields of the sweetest compounds have been one of the main goals of plant breeders and researchers in recent years. (Sun et al., 2021). Seed propagation of stevia has not been a successful technique due to its low germination percentage and high infertility (Yadav et al., 2011; Rasouli et al., 2021).

On the other hand, the conventional vegetative propagation of *S. rebaudiana* is more difficult and at low rate. A great number of resources and space are required for the production of seedlings (Karimi et al., 2015). *In vitro* culture has proven to be a feasible clonal propagation strategy to obtain cultivars with high content of sweetening steviol glycosides (rebaudioside A, stevioside) (Ribeiro et al., 2021). The biochemical pathways in plants are carried out mostly by different plant growth regulators, including auxins, gibberellins, cytokinins, abscisic acid, ethylene, and brassinosteroids (Sharma et al., 2021). Micropropagation techniques guarantee high efficiency and high genetic stability of the propagated material (Sevostyanova et al., 2021). The type and concentration of these plant growth regulators have a remarkable effect on plant physiology. However, the endogenous hormone content can fluctuate between varieties from the same species (Heyman et al., 2021).

Different micropropagation protocols have been developed for the *in vitro* propagation of *S. rebaudiana* plants through direct organogenesis from nodal segment or indirect organogenesis from leaves disk as explants and callus derived leaf segments (Kumari and Chandra, 2015; Shahzad et al., 2017; Matand et al., 2020). The acclimatization phase has been classified as the bottleneck for a

successful propagation protocol of plants. The seedlings must be adapted to the new environmental conditions, such as high light intensity, variable temperature, and low humidity (Dimitrova et al., 2021).

One of the most important aspects of *in vitro* plant propagation is the modification at metabolic and physiological patterns taking place when changing from *in vitro* to *ex vitro* conditions. Plants must be able to fit from a mainly "heterotrophic" nutrition to a completely photoautotrophic nutrition (Ashrafzadeh and Leung, 2021). Several authors have reported that many genes increase their expression, mostly associated with photosynthesis efficiency, chloroplast, and leaf cell development (Eckstein et al., 2012; Cioć et al., 2021; Xiaoying et al., 2022).

Some studies have also shown that the glycoside content depends on the variety, the age of the leaves, and the growing conditions of the plants such as light, temperature, and humidity. On the other hand, all these factors have a strong impact on the glycosylation patterns, affecting the taste perception of the SGs. (Hastoy et al., 2019).

There are few studies related to how the transition from *in vitro* to *ex vitro* conditions might affect the physiological and morphological parameters of the cultivars of *S. rebaudiana*, as well as the impact on gene expression of the genes (*SrKA13H*, *SrUGT74G1* and *SrUGT76G1*) that encode for three major enzymes in the biosynthesis of SGs (stevioside and rebaudioside A). Throughout *ex vitro* conditions, plants must find their own nutrients through the photosynthesis process in the natural environment. These conditions are critical due to the incomplete development of the stomata during the *in vitro* phase, which are not fully functional for photosynthesis in the *ex-vitro* conditions. Therefore, several plantlets do not reach adaptation during this phase, reducing the production yields of the micropropagation cycle (Trofim et al., 2018; Shekhawat et al., 2021).

The aim of this research is to provide a new approach related to the *in vitro* - *ex vitro* transition for *S. rebaudiana* seedlings cv: Morita II, upon morphological, physiological traits. Along with establishing a link between the gene expression (*SrKA13H*, *SrUGT74G1*, and *SrUGT76G1*) and the production of stevioside and rebaudioside A during the *in vitro* - *ex vitro* transition phase. These studies will allow

a better selection of *ex vitro* growth conditions through different substrates mixtures in acclimatization stage in order to increase the SGs yields.

## 2. Materials and methods

### Biological material and growth conditions

The mother plants of *S. rebaudiana* (Bertoni) cv. Morita II was grown for 60 days under culture chambers conditions from the Tissue Culture Laboratory of the Biotechnology Centre of the University of Concepción, Chile. Environmental conditions a temperature of 25°C, relative humidity of 60% and a long day photoperiod (16 h light, 8 h dark), a light intensity of 250  $\mu\text{mol}\cdot\text{m}^{-2}\cdot\text{s}^{-1}$ .

#### 2.1. *In vitro* establishment of *S. rebaudiana* shoots

Juvenile shoots of *ex vitro* plants were grown for approximately 60 days in the conditions of the culture chambers, as described previously. Shoots (10 cm) were cut and washed with running water and commercial detergent. Afterward, shoots were sectioned to a length of 1 cm. The segments of the central part, the second and third internode with two buds, were selected. It was carried out under sterile conditions in a laminar flow cabinet. For the establishment, two factors were evaluated: three concentrations of sodium hypochlorite (NaClO) (0.5, 1.0, and 1.5% v/v) at two exposure times (5 and 10 min). The shoots (1 cm length) were placed in medium (MS) (Murashige and Skoog, 1962) without growth regulators, sucrose 30  $\text{g}\cdot\text{L}^{-1}$ , myoinositol 100  $\text{mg}\cdot\text{L}^{-1}$ , thiamine 1  $\text{mg}\cdot\text{L}^{-1}$  and agar 7  $\text{g}\cdot\text{L}^{-1}$ . The pH of the medium was adjusted to 5.7 before steam sterilization in an autoclave (98.06 kPa for 20 minutes). The culture conditions were a photoperiod of 16 h of light/ 8 h of darkness. Then, a flux of photosynthetically active photons of 40  $\mu\text{mol}\cdot\text{m}^{-2}\cdot\text{s}^{-1}$  (FIEL digital lux meter model FT-710) and a temperature of  $26 \pm 1^\circ\text{C}$  were applied. The survival rate of the shoots was evaluated after 30 days.

## 2.2. *In vitro* multiplication of *S. rebaudiana* shoots

Throughout the multiplication phase, four concentrations of 6-benzylaminopurine (BAP) (Control; 1.1; 2.2; 3.3 and 4.4  $\mu\text{M}$ ) equivalent to Control, 0.25, 0.5, 0, 75 and 1  $\text{mg}\cdot\text{L}^{-1}$  respectively, were evaluated. Shoots with two axillary buds of approximately 1.5 cm from the third subculture were selected. The medium composition and the culture chamber conditions were the same as previously described in section 2.1. The morphological traits such as shoot length, number of internodes per shoot, shoot number per nodal segment and number of leaves per nodal segment were evaluated after 30 days. Five flasks were used per treatment, each with seven explants for a total of 35 replicates.

## 2.3. *In vitro* rooting of *S. rebaudiana*

Shoots selected from the fifth subculture were used to evaluate the effect of indole butyric acid (IBA) and indole acetic acid (IAA) at concentrations of 0, 2.46, 4.92, 7.38 and 9.84  $\mu\text{mol}\cdot\text{L}^{-1}$  equivalent to 0, 0.5, 1.0, 1.5 and 2.0  $\text{mg}\cdot\text{L}^{-1}$ , respectively. The culture chamber conditions were the same as described in section 2.1. The morphological quality indicators such as shoot length, number of internodes per shoot, number of leaves per nodal segment and fresh weight were evaluated after 30 days.

## 2.4. Acclimatization of *S. rebaudiana* cv Morita II

The effect of six substrate mixtures was evaluated based on the morphological and physiological traits: Peat, ferralitic soil plus zeolite (2:1), cachaça plus zeolite (2:1), peat plus zeolite (2:1), ferralitic soil plus cachaça plus zeolite (2:1:1), ferralitic soil plus humus plus zeolite (2:1:1).

Five trays were seeded per treatment for a total of 260 plants. *In vitro* rooted plants were individually seeded in 52-well plastic trays and transferred to the greenhouse for acclimatization. The plants were placed in wooden beds under covers, and sprinkler irrigation of 15 seconds every 60 minutes was established. The environmental conditions were  $80 \pm 3\%$  RH, temperature of  $25.5 \pm 2^\circ\text{C}$  (TECPEL® model DTM-303 digital thermohydrometer), natural photoperiod and light intensity of 400

$\pm 25 \mu\text{mol}\cdot\text{m}^{-2}\cdot\text{s}^{-1}$  (photosynthetic photon flux (FFF)) and atmospheric conditions at a  $\text{CO}_2$  concentration between 330 and 375  $\mu\text{mol}\cdot\text{m}^{-2}\cdot\text{s}^{-1}$  (measured with a FIEL digital luxmeter). Plants survival percentage was determined at 10, 20, and 30 days.

## 2.5. Physiological evaluations

Then plants per treatment were randomly selected for evaluation of the morphophysiological indicators: plant length (cm), number of leaves, number of roots, fresh mass, and dry mass of all organs (Samples were oven dried at 55°C during 72 h), (Segura-Campos et al., 2014). The fresh and dry mass of each plant was weighed subsequently to calculate the physiological parameters. Physiological indicators were calculated from the direct measurements according to Effa et al., (2019).

### Relative growth rate (RGR)

$$\text{RGR} = \frac{(\ln fDW - \ln iDW)}{(fT - iT)} \text{ expressed in } \text{g}\cdot\text{g}^{-1}\cdot\text{d}^{-1}$$

$M_{sf}$  = (final dry mass);  $M_{si}$  = (initial dry mass);  $fT$  = (final time);  $iT$  = (initial time)

### Nate assimilation rate (NAR)

$$\text{NAR} = \frac{(fDW - iDW) - (\ln fFA - \ln iFA)}{(fT - iT)} \text{ expressed } \text{g}\cdot\text{cm}^{-2}\cdot\text{d}^{-1}$$

$fLA$  = (final leaf area);  $iLA$  = (initial leaf area)

**Leaf area:** was determined using a digital image processing system. Images of the leaves were obtained using a scanner (Canon IMAGE CLASS MF 4570DW) and then a square marker of 1  $\text{cm}^2$  area was placed next to the image and the number of pixels of the leaves was determined and referred to the marker.



## 2.6. SGs analysis of *S. rebaudiana* plants cv Morita II

Ten *ex vitro* plants grown on the peat plus zeolite substrate for 30 days throughout acclimatization phase and ten plants from the rooting phase grown under *in vitro* conditions during the same time were selected for the SGs analysis. Woelwer-Rieck et al., (2010) procedure was used for the extraction of SGs. After harvesting, *S. rebaudiana* leaves were freeze-dried at all experimental stages. Samples were ground using a mortar and pestle and liquid nitrogen to produce a fine powder. The samples (12 mg) were weighed and collected in a 2 mL Eppendorf tubes. Subsequently, the extraction process was carried out with a volume of 1.5 mL of ethanol and acetonitrile (1:1; v: v) in a heating block at 102°C for 30 min. Each extract was cooled to room temperature and centrifuged for 15 min at 12000 rpm. The SGs content was expressed in  $\mu\text{g}\cdot\text{mg}^{-1}$  of dry weight.

## 2.7 SGs analysis by HPLC

Rebaudioside A ( $\geq 96\%$  HPLC), and Stevioside standards ( $\geq 98\%$  HPLC) were acquired from Sigma Aldrich, St. Louis, Missouri, USA to be used for the quantitation of SGs levels. A HPLC chromatographic method was carried out under isocratic conditions in a Varian System (Darmstadt, Germany), consisting of a Pro Star 230 pump, and a 335-diode array detector set to a wavelength of 210 nm. A Luna HILIC analytical column (250 x 4.6 mm, 5  $\mu\text{m}$  particle size, Phenomenex, Aschaffenburg, Germany) was used to separate and analyse stevioside and rebaudioside A. The mobile phase consisted of acetonitrile: water (85:15, v: v) adjusted to an isocratic flow rate of 1.0  $\text{mL}\cdot\text{min}^{-1}$  maintained at 25°C.

*S. rebaudiana* glycoside standards (stevioside and rebaudioside A) were prepared by diluting them in acetonitrile and ethanol (1:1) at a concentration of 1  $\text{mg}\cdot\text{mL}^{-1}$  and determined under the conditions run described above (Fig. III.1).

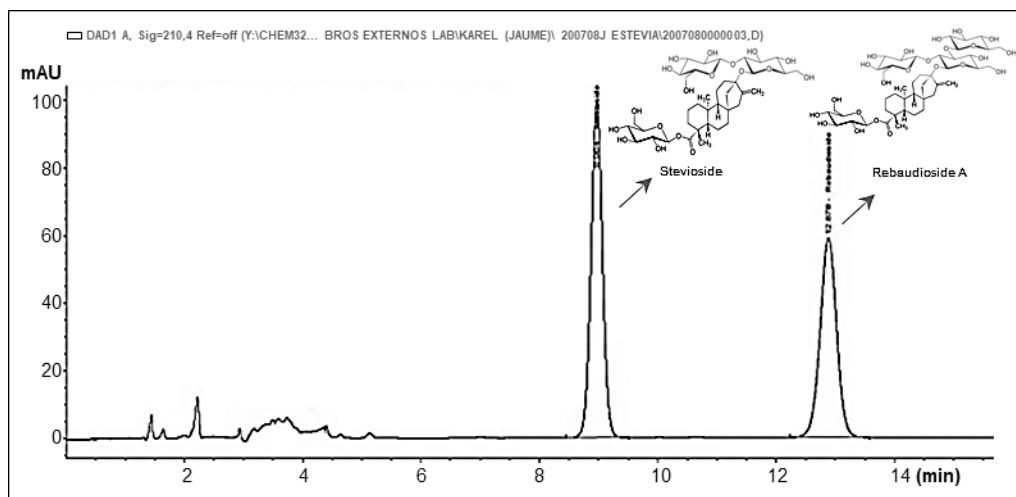

**Fig. III.1.** Chromatograms of steviosides standards solutions (stevioside and rebaudioside A) used for the quantification of *S. rebaudiana* leaves extracts. Intensity of absorbance in milli-Absorbance Units (mAU).

## 2.8. Gene expression analysis by RT-qPCR

RNA was extracted from leaves (ca. 80 mg of fresh weight per biological replica) and purified using the Qiagen RNeasy Plant Mini Kit or the semiautomatic Maxwell kit Simply RNA (Promega). The RNA (2  $\mu\text{g}$ ) was reverse transcribed using M-MLV reverse transcriptase (Invitrogen) or Transcription First Strand cDNA synthesis (Roche, Sweden) RT-qPCR analysis was performed in a LightCycler 480 System Reference housekeeping gene used were  $\beta$ -ACTIN and EF1 $\alpha$ . The list of primers used for RT-qPCR amplification, efficiency, and the resulting product size are specified in Table III.1. Quantification of gene expression was performed as indicated by Gan et al., 2016.

**Table. III.1.** List of primers used for real-time PCR amplification and the resulting product size (Vives et al., 2022).

Sequence of primers	Accession number	Amplicon size bp	Efficiency	Reference
<b>SrKA13H</b>				
F: 5'-CCGACTCCATTACGTTTGT-3'	DQ398871.3	206	1.94	<a href="https://www.ncbi.nlm.nih.gov/pubmed/26438788">https://www.ncbi.nlm.nih.gov/pubmed/26438788</a>
R: 5'-ACTTGATGGGGATGAAGACG-3'				
<b>SrUGT74G1</b>				
F: 5'-TGTTTCGGTTCCTGGATTTC-3'	AY345982.1	139	2	<a href="https://pubmed.ncbi.nlm.nih.gov/15610349">https://pubmed.ncbi.nlm.nih.gov/15610349</a>
R: 5'-GAAGACCCAACGTGCTTGAT-3'				
<b>SrUGT76G1</b>				
F: 5'-AGCGTTTGTGAAGGTGTTCC-3'	AY345974.1	115	1.91	<a href="https://pubmed.ncbi.nlm.nih.gov/15610349">https://pubmed.ncbi.nlm.nih.gov/15610349</a>
R: 5'-CCCACCCATTTTCCAAATAC-3'				
<b><math>\beta</math>Actin</b>				
F: 5'-AGCAACTGGGATGACATGGAA	AF548026	65	1.87	<a href="https://www.ncbi.nlm.nih.gov/pubmed/30150853">https://www.ncbi.nlm.nih.gov/pubmed/30150853</a>
R: 5'-GGAGCGACACGAAGTTCATTG				
<b>EF1<math>\alpha</math></b>				
F: 5'-ATGCTCTTCTTGCTTTCACCTC-3'	AY157315	104	2	<a href="https://www.ncbi.nlm.nih.gov/nucore/26324157">https://www.ncbi.nlm.nih.gov/nucore/26324157</a>
R: 5'-GATTCTTCATACCTCGCCT-3'				

## 2.9. Statistical analysis

SPSS (Version 12 for Windows, SPSS Inc.) was used for statistical processing and analysis of the data. A simple two-factor analysis of variance (ANOVA) with different levels was used. Treatment means were compared using Tukey's multiple range test ( $p < 0.05$ ). In some cases, it was necessary to transform the data to meet the parametric tests' assumptions.

## 3. Results

### 3.1. *In vitro* establishment of *S. rebaudiana* shoots cv Morita II

Different NaClO concentrations and exposure times were tested based on several published protocols to make a positive selection based on parameters such as the percentage of survival in the establishment stage. We showed that the shoots subjected to the concentration of 1% NaClO for 5 min reached the highest percentage of survival (60%) with respect to the other treatments Fig. III.2.

We observed that the treatment at the lowest NaClO concentration got significant differences respect to the exposure time. However, the survival percentage decreased due to most of the

explants died due to a bacterial contamination. The lowest percentage of survival was observed at the highest concentration of NaClO (1.5%), regardless of the exposure time.

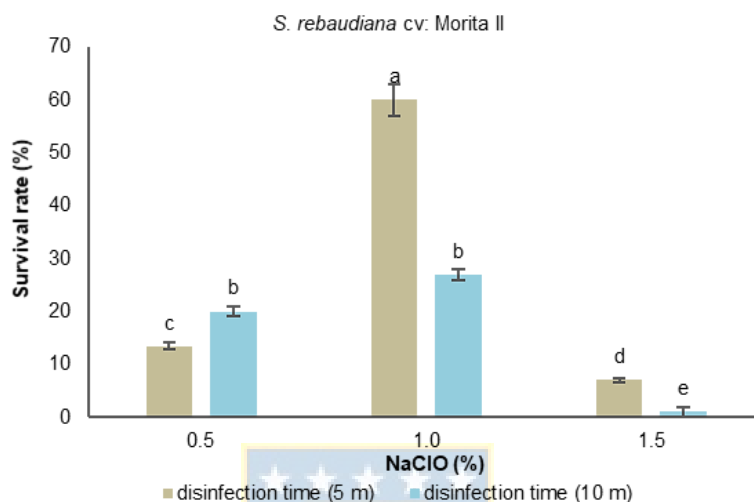

**Fig. III.2.** Effect of exposure time at three concentrations of sodium hypochlorite (NaClO) on the survival percentage of *S. rebaudiana* cv. Morita II explants. Means with unequal letters represent statistically significant differences ( $p \leq 0.05$ ) (one factor ANOVA, Tukey) ( $n = 15$ ). For the statistical treatment, the data were transformed according to  $y' = 2 \cdot \arcsin(X/100)^{1/2}$ . \* Data represent the mean of 15 internodes per treatment.

### 3.2. *In vitro* multiplication of *S. rebaudiana* shoots

The highest number of shoots per explant was observed at concentrations of 2.2 and 3.3  $\mu\text{mol}\cdot\text{L}^{-1}$  (Table III.2). However, the control treatment reached the highest values on the other morphological traits evaluated: shoot length, number of internodes, and leaves per shoots. Although, no significant differences for the number of leaves were registered based on the concentrations of 1.1 and 2.2  $\mu\text{mol}\cdot\text{L}^{-1}$  of BAP. The effect of different concentrations of BAP on morphological indicators during the multiplication stage is presented in Table III.2.

**Table III.2.** Effect of BAP concentrations during the multiplication phase on *S. rebaudiana* plants cv: Morita II.

BAP ( $\mu\text{mol}\cdot\text{L}^{-1}$ )	0	1.1	2.2	3.3	4.4
Shoot length (cm)*	5.9 $\pm$ 0.2 a	2.7 $\pm$ 0.3 b	2.9 $\pm$ 0.3 b	1.8 $\pm$ 0.3 c	1.5 $\pm$ 0.3 c
Number of internodes per shoot formed*	3.0 $\pm$ 0.8 a	2.2 $\pm$ 0.2 b	1.8 $\pm$ 0.5 bc	1.6 $\pm$ 0.3 c	1.5 $\pm$ 0.4 c
Shoot number per nodal segment	2.0 $\pm$ 0.3 c	3.0 $\pm$ 0.5 c	7.0 $\pm$ 0.1 ab	8.0 $\pm$ 0.2 a	6.0 $\pm$ 0.5 b
Number of leaves per nodal segment	10.0 a $\pm$ 0.2	8.0 a $\pm$ 0.2	8.0 a $\pm$ 0.3	7.0 b $\pm$ 0.2	6.7 b $\pm$ 0.3

Results with the same letter are not statistically different Means with unequal letters have statistically significant differences (bifactorial ANOVA, Tukey,  $p \leq 0.05$ ,  $n = 35$ ). The variables number of shoots, number of internodes and number of leaves were transformed according to  $y' = (X)^{1/2}$ .

The shoot quality was reduced in several traits such as the number of internodes, their height, and the number of leaves at higher concentrations (Fig. III.3). On the other hand, a marked decrease in shoots height was observed as the concentration of BAP increased and the presence of a purplish color on the leaves surface was more evident (Fig. III.3). Based on these results,  $0.25 \text{ mg}\cdot\text{L}^{-1}$  of BAP was used, alternating with subcultures to MS medium without growth regulators to achieve a balance between all the morphological indicators evaluated. The selection of the appropriate concentration of growth regulators in the multiplication stage is generally based on choosing the explants with the highest number of shoots generated. However, in our research, the morphological indicators were evaluated as a selectivity pattern that allowed us to select shoots with higher quality.

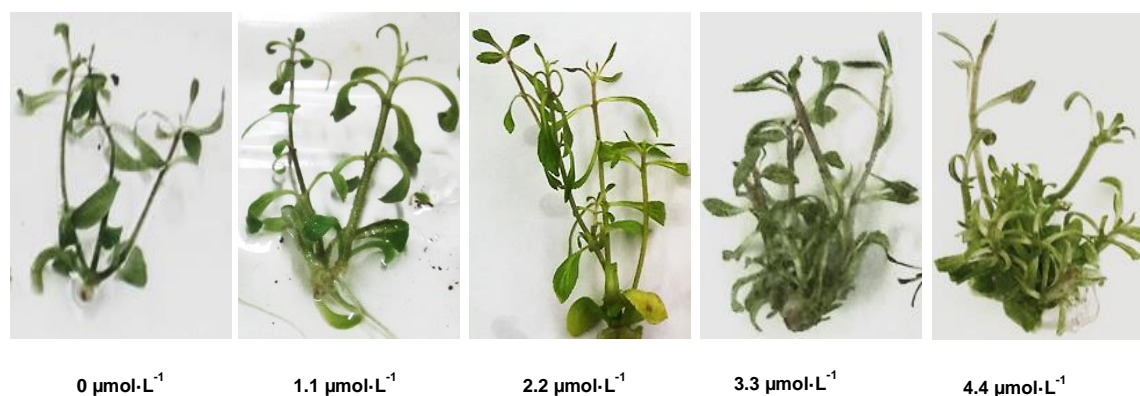

**Fig. III.3.** Morphological appearance of *S. rebaudiana* plants cv. Morita II 21 days after being subjected to different BAP concentrations (0; 1.1; 2.2; 3.3 and  $4.4 \mu\text{mol}\cdot\text{L}^{-1}$ ).

### 3.3. *In vitro* rooting of *S. rebaudiana* shoots

The effect of two auxins, IAA and IBA over was assessed based on the rooting percentage and sundry morphological traits (Table III.3). The morphological quality indicators such as shoot length, number of internodes, and number of leaves, registered the highest values at the concentration of  $2.46 \mu\text{mol}\cdot\text{L}^{-1}$  of the IAA when compared to other treatments. However, no significant differences were observed compared to the control treatment based on the analysis between both factors: types of auxins and concentrations.

**Table. III.3.** Effect of different concentrations and type of auxin during the rooting phase on *S. rebaudiana* plants cv: Morita II.

Type of auxin	Auxin Concentration ( $\mu\text{mol}\cdot\text{L}^{-1}$ )	Shoot length (cm)	Internodes per shoot (N°)	Leaves per nodal segment (N°)	Fresh weight (FW) (mg)
<b>IBA</b>	0	7.46 a	3.7 bcd	13.0 ab	0.19 cd
	2.46	7.34 a*	4.9 a*	15.5 a*	0.15 d
	4.92	3.19 c	3.3 d	12.2 bcd	0.34 ab
	7.38	3.10 c	3.3 d	10.5 cd	0.27 bc
	9.84	3.69 bc	3.6 bcd	10.1 d	0.42 a*
<b>IAA</b>	0	7.46 a*	3.7 a*	13.0 ab	0.19 cd
	2.46	3.60 bc	4.02 ab	15.5 a*	0.14 d
	4.92	4.63 b	4.25 ab	14.2 ab	0.15 d
	7.38	3.26 bc	3.8 bc	13.0 bc	0.20 d
	9.84	3.46 bc	3.4 bcd	12.2 bcd	0.13 d

Results with the same letter are not statistically different Means with unequal letters have statistically significant differences (bifactorial ANOVA, Tukey,  $p \leq 0.05$ ,  $n = 35$ ). The variables number of shoots, number of internodes and number of leaves were transformed according to  $y' = (X)^{1/2}$ .

The rooting percentage did not show significant differences between IAA and IBA at the lowest concentrations (Fig. III.4). It was observed that as the IBA concentration increased, the rooting percentage decreased. On the other hand, the rooting percentage was higher with IAA used at lower concentrations (0;  $2.46$  and  $4.92 \mu\text{mol}\cdot\text{L}^{-1}$ ).

The sprouts' quality did not vary between the treatments evaluated with respect to the concentration (Fig. III.4B and III.4C). However, it was observed that the quality of the shoots evaluated between the

types of growth regulators (A) IAA and IBA (B) showed a marked difference, especially in the presence of roots, where the appearance of collagenic structures is visible in the base of shoots treated with IBA.

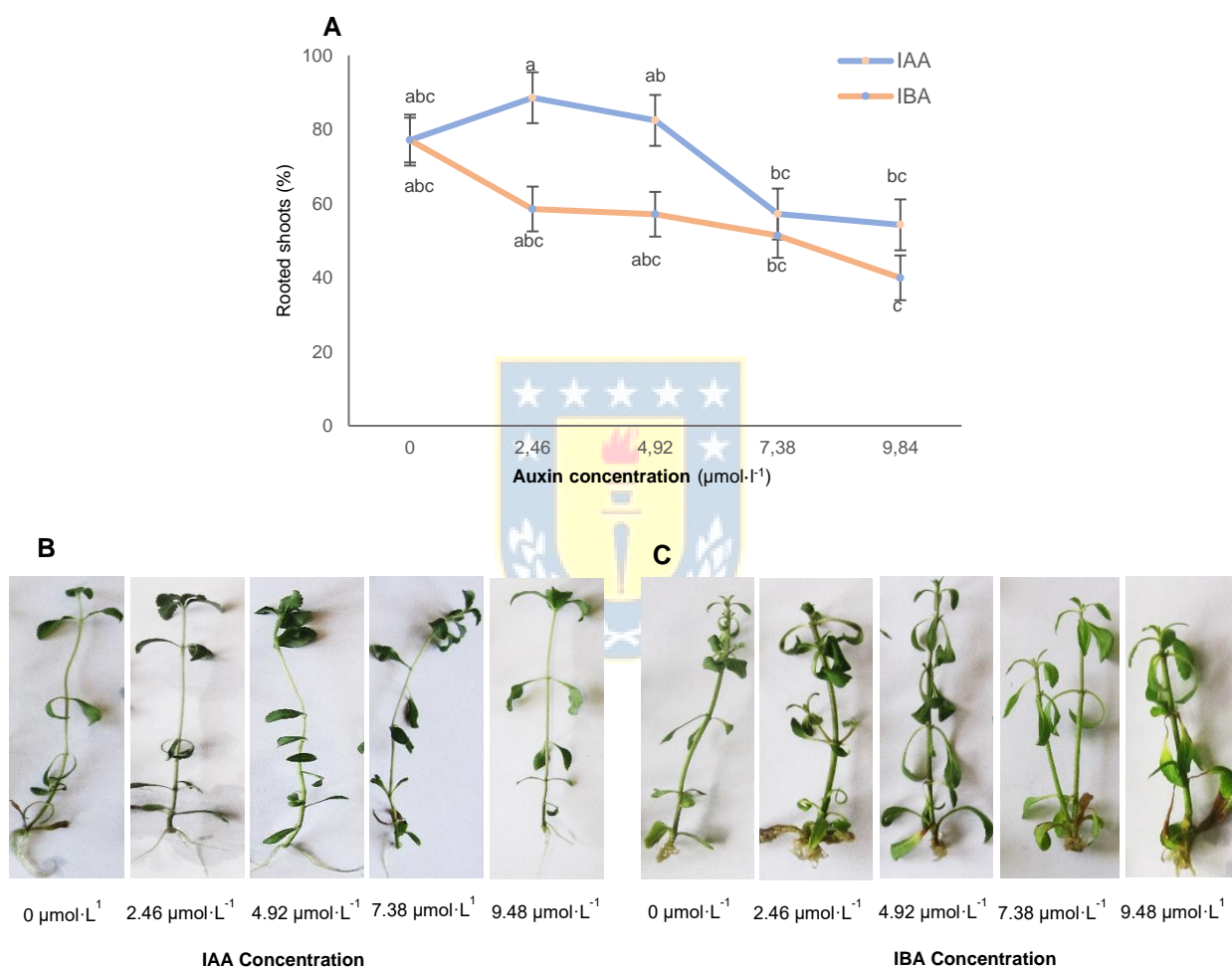

**Fig. III.4. (A)** Comparison of the effect IAA and IBA auxin concentrations on the rooting percentage of *S. rebaudiana* cv: Morita II. Means with unequal letters have statistically significant differences (bifactorial ANOVA, Tukey,  $p \leq 0.05$   $n = 35$ ). The data were transformed according to  $y' = \arcsin(X + 0.5)^{1/2}$ . General mean = 62.98%. Standard error of the mean = 7.22%. Morphological appearance of *S. rebaudiana* cv. Morita II 21 days after being subjected to four concentrations of auxins **(B)** IAA (0, 2.46, 4.92, 7.38 and 9.84  $\mu\text{mol}\cdot\text{L}^{-1}$ ) and **(C)** IBA (0, 2.46, 4.92, 7.38 and 9.84  $\mu\text{mol}\cdot\text{L}^{-1}$ ).

### 3.4. Effect of different substrates on plant survival and physiological indicators during acclimatization of *S. rebaudiana* cv. Morita II

The successful *ex vitro* establishment of *in vitro* cultured *S. rebaudiana* shoots determines the ultimate success of the propagation protocol. The peat and zeolite mixture registered the most stable and highest survival values during the month of evaluation (Table III.4).

**Table. III.4.** Effect of different types of substrates on the survival rate (%) of *S. rebaudiana* cv: Morita II plants in the acclimatization phase at 10, 20 and 30 days.

Substrates	10 days	20 days	30 days
Peat	98 a	93 a	88 b
Ferralitic soil + Zeolite	95 a	93 a	80 c
Cachaça + Zeolite	92 a	76 cd	60 e
Peat + Zeolite	97 a*	93 a*	92 a*
Ferralitic soil + Cachaça + Zeolite	87 b	79 c	71 d
Ferralitic soil + Peat + Zeolite	89 ab	86 b	83 bc

Means with different letters have statistically significant differences (ANOVA, Tukey,  $p \leq 0.05$  n = 10. The percentage variable was transformed according to  $y = \arcsine (X + 0.5 / 100)^{1/2}$

On the other hand, significant differences were observed among the different mixtures of substrates (Table III.5). Plants grown in the combination of peat plus zeolite had a positive effect on the different morphophysiological indicators evaluated. These plants achieved the highest values in morphological traits such as seedling height, number of leaves per plant and the number of roots.

Finally, the physiological indicators of relative growth rate and the net assimilation rate of the plants grown during 30 days of acclimatization in six substrate mixtures; did not registry significant differences between the treatments evaluated (Table III.6). However, the physiological indicator of leaf area was higher in the mixture of peat and zeolite when compared to the other treatments (Fig. III.5).



**Table. III.5.** Effect of different types of substrates on morphological quality indicators in *S. rebaudiana* cv: Morita II plants 30 days after acclimatization.

Substrates	Shoot length (cm)	Leaves/ Plant (N°)	Root/Plant (N°)	FW Plant (mg)	FW Leaves (mg)	FW Root (mg)
Peat	10.9 ab	12.0 bc	4.0 c	590 ab	330 ab	70 b
Ferralitic soil + Zeolite	9.6 b	9.0 c	7.0 b	500 b	190 b	150 ab
Cachaça + Zeolite	10.9 ab	12.0 abc	6.0 b	500 b	280 ab	50 ab
Peat + Zeolite	1.4 a*	14.0 a*	13.0 a*	810 a*	410 a*	180 a*
Ferralitic soil + Cachaça + Zeolite	9.0 b	13.0 ab	7.0 b	560 b	300 ab	110 ab
Ferralitic soil + Peat + Zeolite	10.5 ab	13.0 ab	7.0 b	410 b	220 b	90 ab

Means with unequal letters have statistically significant differences (ANOVA, Tukey,  $p \leq 0.05$ ,  $n = 30$ ). The variables number of leaves and internodes was transformed according to  $y' = (X)^{1/2}$ .

**Table. III.6.** Effect of the different types of substrates on the physiological indicators: relative growth rate (RGR) and net assimilation rate (NAR) of *S. rebaudiana* cv: Morita II plants 30 days after acclimatization.

Substrates	RGR ( $g \cdot g^{-1} \cdot día^{-1}$ )	NAR ( $g \cdot cm^{-2} \cdot d^{-1}$ )
Peat	0.059	0.027
Ferralitic soil + Zeolite	0.060	0.014
Cachaça + Zeolite	0.061	0.041
Peat + Zeolite	0.060	0.025
Red Ferralitic soil + Cachaça + Zeolite	0.060	0.032
Red Ferralitic soil + Peat + Zeolite	0.060	0.079
	NS	NS

Medias con letras desiguales tienen diferencias estadísticamente significativas (ANOVA, Tukey,  $p \leq 0,05$ ,  $n = 10$ ).

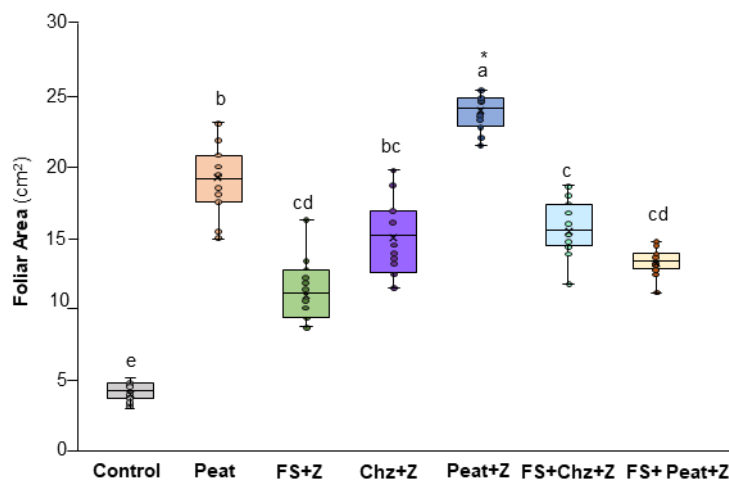

**Fig. III.5** Effect of different substrate mixtures on the leaf area of *S. rebaudiana* cv: Morita II plants grown for 30 days in acclimatization. Medias con letras desiguales tienen diferencias estadísticamente significativas (ANOVA, Tukey,  $p \leq 0,05$ ,  $n = 10$ ).

### 3.5. Characterization of *S. rebaudiana* cv: Morita II according to SGs production and relative gene expression

The SGs total production (stevioside and rebaudioside A) from plants grown *ex vitro* for 30 days was significantly higher than those produced by plants from the *in vitro* rooting phase. The concentration of rebaudioside A increased significantly till  $36,7 \mu\text{g}\cdot\text{mg}^{-1}$  of dry weight in seedlings 30 days after being in acclimatization, while stevioside content reached  $3,5 \mu\text{g}\cdot\text{mg}^{-1}$  of dry weight at the same sample point. Both compounds showed significantly differences compared with shoots coming from *in vitro* conditions: rebaudioside A  $4,19 \mu\text{g}\cdot\text{mg}^{-1}$  of dry weight and stevioside  $1,77 \mu\text{g}\cdot\text{mg}^{-1}$  of dry weight. In addition, the production ratios between stevioside and rebaudioside A were higher in acclimatized plants when compared to plants grown under *in vitro* conditions (Fig. III.6).

The differential gene expression of *SrKA13H*, *SrUGT74G1*, and *SrUGT76G1* in charge of the main enzymes responsible for the synthesis of rebaudioside A and stevioside was analyzed during the *in vitro* – *ex vitro* transition. Plants from *in vitro* rooting conditions were compared to plants grown under *ex vitro* conditions (acclimatation) with peat plus zeolite substrate mix. The expression of *SrKA13H*,

*SrUGT74G1* and *SrUGT76G1* genes was higher in plants acclimatized in the peat plus zeolite substrate when compared to seedlings from rooting *in vitro* conditions. The relative gene expression of the *SrKA13H* and *SrUGT76G1* genes reached the highest values in plants acclimatized during 30 days, while *SrUGT74G1* showed the lowest levels of expression at the same sampling point (Fig. III.7).

The correlation between SGs production (the sum of stevioside and rebaudioside A) and the expression of the genes encoding the enzymes that participate in their biosynthesis was analyzed (Fig. III.6). The levels of gene expression *SrKA13H*, *SrUGT74G1*, and *SrUGT76G1* increase considerably during the transition process from *in vitro* rooting conditions to *ex vitro* acclimatization in greenhouses (Fig. III.7). Furthermore, the specialized metabolites SGs stevioside and rebaudioside A analyzed increase linked to the gene expression.

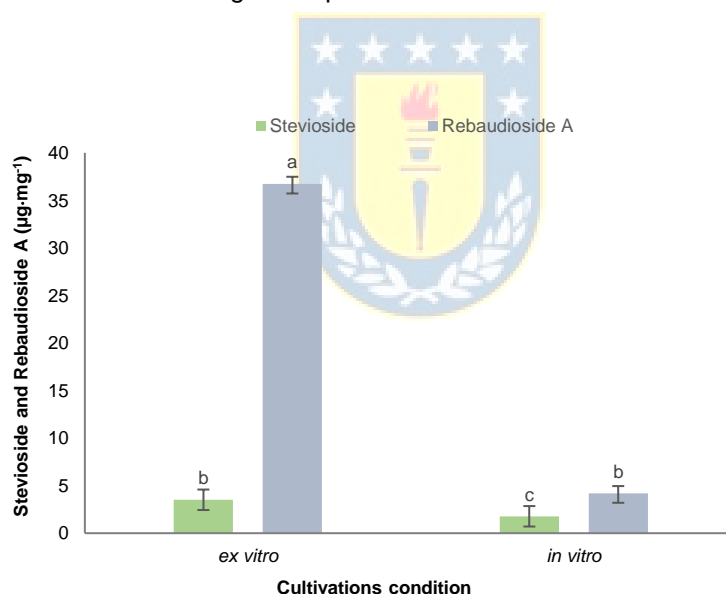

**Fig. III.6.** Comparison of the content of stevioside and rebaudioside A ( $\mu\text{g}\cdot\text{mg}^{-1}$  of dry weight) between *S. rebaudiana* plants grown *ex vitro* for 30 days after being acclimatized and *in vitro* plants from the rooting phase. The results with the same letter are not statistically different (one-way ANOVA, Tukey,  $P > 0.05$ ) \*  $n = 8$ .

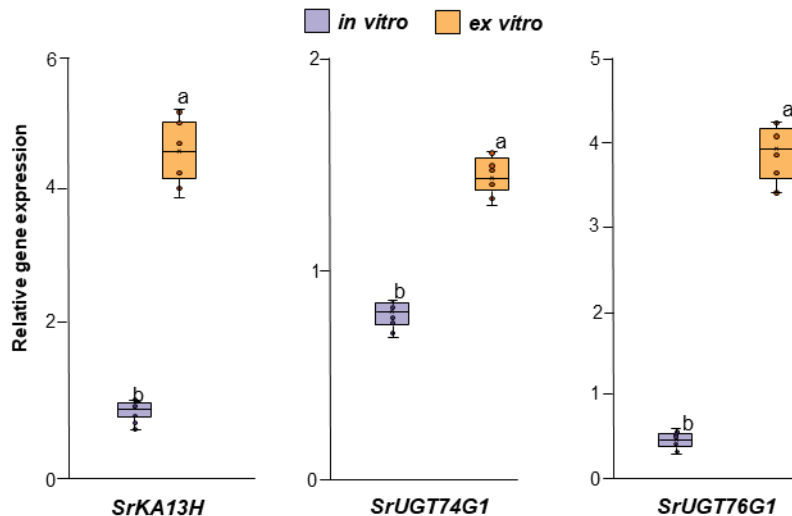

**Fig. III.7.** Comparison of the relative expression of the main genes that regulate the metabolic pathway for the synthesis of stevioside and rebaudioside A among *Stevia rebaudiana* cv. Morita II plants, grown *in vitro* in the rooting phase with plants acclimatized in the mixture of peat and zeolite substrate grown for 30 days. Transcription levels were normalized against reference genes. Each bar represents the mean. Error bars represent the standard deviation of the mean (n=8). The different letter above each bar indicates significant differences (Tukey-Kramer method,  $P < 0.05$ ).

## 4. Discussion

### 4.1 Effect of concentrations of (NaClO) and exposure time on the survival percentage of shoots of *S. rebaudiana* cv: Morita II

During the *in vitro* establishment phase, it is crucial to find an effective procedure that allows the eradication of spores, fungal tissue, bacteria, and other contaminants with no damage to the explant plant tissue or the reduction of its regenerative capacity (Cassells, 2012; Ngone et al., 2021). A proper selection of the disinfecting agent, the concentration, and the exposure time play a key role in introducing *ex vitro* material to *in vitro* conditions (Deshmukh et al., 2019).

The highest survival percentage was reached at a concentration of 1% NaClO and 5 min exposure time. This survival percentage is lower than that reported by Urbi and Zainuddin (2015), whom observed that the treatment of explants with NaClO at a concentration of 5% NaClO for 10 minutes

was more effective than  $\text{HgCl}_2$ . They reported a much higher NaClO concentration to obtain a better survival rate, with a 3% damage in the seedlings, and a fungi contamination of 10%, despite combining the use of NaClO and fungicide in their protocol. Other authors have used NaClO at concentrations from 0.5% to 5% of active chlorine, specifically for Morita I at 1.25% for 15 minutes (Suarez and Quintero, 2014). However, sodium hypochlorite (NaOCl) is one of the main substances used for surface sterilizing plant material because of its low cost and high availability (Hesami et al., 2018).

The *in vitro* propagation technique is an attractive option in a short time for large-scale production of species such as *S. rebaudiana* (Mahendran et al., 2019). Due to the medicinal and industrial importance of *S. rebaudiana* and its growing demand granted by the presence of secondary metabolites such as SGs, it continues to be a challenge to obtain homogeneous and vigorous plants in a short period (Libik-Konieczny et al., 2021). It must be taken into consideration that the use of different types of disinfectant agents can increase the micropropagation protocol cost. Hence, the usage of low NaClO concentrations was selected to achieve 60% success in the establishment of shoots of *Stevia rebaudiana* cv. Morita II.

#### **4.2. Effect of concentrations of BAP during *in vitro* multiplication of *S. rebaudiana* shoots**

Numerous authors have reported the usage of BAP in the proliferation of shoots of *S. rebaudiana*. However, some of them did not emphasize the negative effect that high concentrations of BAP can have on the morphological quality of shoots (Yadav et al., 2011; Aremu et al., 2020). The possibility of obtaining high quality shoots in the multiplication stage was explored by testing the effect of four BAP concentrations. Several authors did not specify the cultivar used for the experiments (Banerjee et al., 2019).

The number of shoots obtained was similar to those reported by Thiagarajan and Venkatachalam (2012), whom demonstrated that BAP was the most efficient cytokinin for shoot regeneration compared to KIN. The frequency of plant regeneration and the number of shoots per crop was higher

with increased BAP concentrations of up to  $4.4 \mu\text{mol}\cdot\text{L}^{-1}$ . However, the frequency of shoot regeneration and the number of shoots decreased as the BAP concentration increased above  $4.4 \mu\text{mol}\cdot\text{L}^{-1}$  (Dkm Gunasena and Senarath, 2019). It was observed that while the concentration of BAP increased, the quality of the shoots decreased. The height of the shoots was lower, and the leaves were deformed and smaller (Figure 2).

These results are similar to those obtained by Röck-Okuyucu et al. (2016), whom reported that BAP concentrations greater than  $4.44 \mu\text{mol}\cdot\text{L}^{-1}$  resulted in the growth of bushy-looking seedlings, very thin shoots, and small leaves. These conditions were deemed not suitable for *in vitro* plant propagation. The effect of plant growth regulators can change significantly depending on their endogenous content in plants. Hence, selecting one cultivar or the other within the *S. rebaudiana* species can play a key role in the effect of differences observed in previous studies for the same specie (Blinstrubiene et al., 2020). Based on the results for the Morita II cultivar, it was decided to use  $1.1 \mu\text{mol}\cdot\text{L}^{-1}$  of BAP during the subcultures, alternating with subcultures to MS medium without plant growth regulators to achieve a better quality the shoots.

#### **4.3. Effect of IAA and IBA concentrations during *in vitro* rooting of *S. rebaudiana* shoots**

Due to the great diversity of criteria in previous studies and the variability about the concentrations or type of auxin, it is worth it to look for alternative to achieve higher rooting percentages. Other types of auxins were used: IAA and IBA at concentrations described in section 2.3. Previously works carried out by Yücesan et al. (2016) shown results similar to those described in these experiments, where the usage of IBA was effective for rooting. The rooting percentage was slightly lower than induced by 0.25 or  $0.5 \text{ mg}\cdot\text{L}^{-1}$  of IAA (85.5 and 87.6%).

Suarez and Quintero. (2014) tested different concentrations of ANA (0, 0.5, 1.0, 2.0, and  $4.0 \text{ mg}\cdot\text{L}^{-1}$ ) in the *in vitro* rooting of the shoots of Morita I. The highest rooting percentage (87%) was achieved at an ANA concentration of  $2 \text{ mg}\cdot\text{L}^{-1}$  and up to four roots were obtained per shoot. This result contrasts with those obtained in a preliminary test (results not shown) carried out in the rooting

of Morita II, where only 71% of the shoots rooted at the concentration of 0.5 mg·L<sup>-1</sup> of ANA. Only the 60% of the shoots differentiated its *in vitro* roots at a highest concentration of 2 mg·L<sup>-1</sup> of ANA.

The highest rooting percentages were observed at the concentration of 1 mg·L<sup>-1</sup> of IAA and IBA, both (86% to 93%). The roots differentiation decreased with the increase of the concentration of auxins and control (without auxins). No root formation was observed in this condition. Contrasting results were obtained when these experimental conditions were tested by Amien et al. (2021) and Magangana et al. (2021).

Overall, IAA had a more significant effect on root formation than IBA. This effect was more marked at the concentration of 0.5 mg·L<sup>-1</sup>. The plants of the control treatment (without auxins) showed rooting levels without significant differences compared to the concentrations of 2.46 and 4.92 μmol·L<sup>-1</sup> of IBA (Figure 4). As a novelty, it was noticed that *S. rebaudiana* shoots grown without (BAP) in the multiplication phase and showed root formation.

#### **4.4. Effect of different substrates on plant survival and physiological indicators during acclimatization of *S. rebaudiana* cv. Morita II**

The change from *in vitro* to *in vivo* conditions (greenhouse) is crucial for the adaptation of the plants and means that the plants go through a period of acclimatization for them to survive (Klimeket al., 2015). During this stage, plants are forced to form new functional roots and shoot to a full conversion to photoautotrophic plants (Shekhawat et al., 2021). The success of the acclimatization stage in plants is conditioned by factors such as humidity, type, substrate quality, temperature, and agronomic management (Khandel et al., 2021). One of the main indicators to evaluate in the acclimatization stage is the survival rate (Seon et al., 2000).

Considerable efforts have been made to optimize the conditions for the *in vitro* culture steps in *S. rebaudiana* plants. Studies related to the acclimatization process for this species, are still few, and this stage is crucial for a successful development of a micropropagation protocol (Angelini et al., 2016). Manjusha and Sathyanarayana (2010) evaluated the immersion of *S. rebaudiana* shoots in

solutions at different concentrations of BAP to improve the survival percentages in the acclimatization stage. They observed that the usage of 3 mg·L<sup>-1</sup> resulted in a greater number of multiple shoots, average growth parameters and a higher percentage of survival 75.80%, 25.29%, above the control that was observed at 60.50%. In contrast to these results, a higher survival rate of 92% was observed in shoots of *S. rebaudiana* cv Morita II grown on the substrate formulated by peat and zeolite 1:1 (v:v) and without applying additional plant growth regulators (Table 3).

Several substrate mixes have been used to increase the survival rate during ex vitro adaptation (acclimatization) of numerous micropropagated plant species (Suárez et al., 2020, Rahman et al., 2021). However, there are awfully few reports on the effect of how the properties of different formulations of substrates can play a crucial factor in the rapid acclimatization of species such as *S. rebaudiana* assessed by the morphophysiological and molecular traits. Some other authors such as Anbazhagan et al. (2010) found 82% survival of *S. rebaudiana* plants with the use of a sand-soil-vermicompost substrate mixture in a 1:1:1 ratio for 4 weeks. On the other hand, Suarez and Quintero. (2014) pointed out that a 67% of the *S. rebaudiana* seedlings (variety Morita I) stems without in vitro rooting and without exogenous auxin treatment were able to adapt to ex vitro conditions in the acclimatization. These authors refer to the usage of a 1:1 ratio for the mixture of soil-sand under 50% poly-shade and with permanent irrigation for 8 weeks. The number of plants that survived in ex vitro conditions was recorded as 92% at 30 days grown.

It was observed that the mixture Peat + zeolite (1:1) significantly increased all the parameters evaluated. This may be attributed to the intrinsic characteristics of both substrates that could increase the availability of nitrogen, phosphorus, and sulfur for the plants, improving the physical properties, modifying the structure, and increasing the number of pores in the substrate (Nakhli et al., 2017; Zanin et al., 2020). As a novelty, our work provided an integrated study on the effect of different substrates on a wide number of physiological, morphological, and biochemical traits during the acclimatization stage, which may be useful in the production of *S. rebaudiana* plants cv: Morita II, by means of micropropagation techniques.



#### 4.5. Characterization of *S. rebaudiana* cv: Morita II cultivars according to SGs production and relative gene expression

The micropropagation of plants with desirable traits have been a cornerstone of social development throughout history. Its current technological application ranges from ornamental, agricultural and medicinal plants use, with application in agriculture and the pharmaceutical industry (Banerjee et al., 2019). One of the most biologically booked and low-calorie sweeteners are those obtained from the leaves of *S. rebaudiana*, which has generated its extensive cultivation worldwide to produce SGs such as stevioside and rebaudioside A, specialized metabolites with a sweetness 250 to 450 times greater than from sucrose (Sun et al., 2021).

In our research, we focus on the effect transition might have, from photo mixotrophic conditions (in vitro) to photoautotrophic conditions during the acclimatization stage (*ex vitro*) could have on the relative gene expression of the main enzymes of the metabolic pathway, as well as in the production of stevioside and rebaudioside A.

In order to elicit a higher production of SGs, several authors have studied how to increase the levels of gene expression of the main enzymes on metabolic pathway of SGs, through the use of osmotic elicitors such as NaCl and mannitol under *in vitro* conditions (Ghaehri et al., 2019). They observed that the control treatment showed the highest expression levels with respect to increased NaCl concentrations. On the other hand, studies on the effect of different concentrations of mannitol favored, in some cases, the differential increase of genes such as *SrUGT74G1*, while the expression of others such as *SrUGT76G1* did not differ significantly (Azzam et al., 2021). The relative gene expression of *SrKAH13*, *SrUGT74G1* and *SrUGT76G1* observed in our experiments were similar to those obtained by these authors in the control treatment, taking into account that our *in vitro* protocol did not seek to elicit the expression or production of SGs under in vitro conditions. The percentages of the content of stevioside and rebaudioside A reported by these works were not properly described and justified (Azzam et al., 2021). The *S. rebaudiana* shoots cultivated for 30 days in vitro during

rooting stage showed low levels of gene expression and low contents of stevioside and rebaudioside A.

A statistically significant difference was observed for the content of stevioside and rebaudioside A, between *ex vitro* plants grown in the peat and zeolite substrate mixture, when compared with plants from *in vitro* rooting. In most of the *in vitro* propagation systems, the typical PFD is around  $40 \mu\text{mol}\cdot\text{m}^{-2}\cdot\text{s}^{-1}$ , which is ten times lower than light levels in *ex vitro* environments, which correlates with natural shading. The biomass accumulation is reduced in a lower energy environment, which includes lower ATP synthesis capacity and lower reducing power (NADPH). Low carbon-binding capacity tends to be reflected during acclimatization, with an additional probability of photoinhibition when photoprotection mechanisms are underdeveloped (Singh et al., 2017; Neto et al., 2020).

The variations in the differential gene expression of the *SrKAH13*, *SrUGT74G1* and *SrUGT76G1* enzymes, and the production of stevioside and rebaudioside A have not been previously addressed according to the changes that take place when passing from mixotrophic conditions (*in vitro*) to fully photoautotrophic conditions (*ex vitro*). As a novelty, it was observed that a great change occurs with respect to the relative expression of the genes *SrKAH13* and *SrUGT76G1* when comparing plants grown for 30 days in the rooting stage in MS medium with plants grown for the same time in a mixture of peat and zeolite substrate during the acclimatization stage. This increase was significant 30 days after the plants were in acclimatization (Fig 6). Although a significant difference was observed in the expression of *SrUGT74G1* between plants *in vitro* and *ex vitro*, the expression of this gene was observed at the lowest relative level. The increase in the relative expression of the genes *SrKAH13*, *SrUGT74G1* and *SrUGT76G1*, and the production of stevioside and rebaudioside A in plants grown *in vitro* during rooting was compared to results for plants after 30 days of acclimatization. This indicated that the plants laying to produce a high content of these compounds in a short period of time under the *ex-vitro* conditions.

## 5. Conclusions

The design and improvement of a micropropagation protocol emphasizing on the acclimatization stage for *S. rebaudiana* cv. Morita II offers a new alternative for the obtention of seedlings with higher survival rates. It was found that the mixture of peat and zeolite substrates favored all the studied physiological parameters, as well as the higher production of stevioside and rebaudioside A. On the other hand, when evaluating the implication during transition from in vitro conditions (mixotrophic) compared to ex vitro plants (photoautotrophic) during a time of 30 days, a marked difference was observed in the increment of the relative expression of the studied genes, as well as in the production of stevioside and rebaudioside A. All these elements have a great relevance for the worldwide commercialization of sweeteners, as well as to promote its use in the food and pharmaceutical industries.

### Declaration of competing interest

The authors declare that they have no known competing financial interests or personal relationships that could have appeared to influence the work reported in this paper.

### Acknowledgements

The authors would like to thank ANID for the grant that allowed a research stay in the laboratory at Centre for Research in Agricultural Genomics (CRAG), CSIC-IRTA-UAB-UB in Barcelona, Spain. We also want to acknowledge the technical support of Rosa Rodriguez Goberna (CRAG) in the HPLC analyses.

### Funding

This work was supported by the European Commission [H2020-MSCA-IF-2017, grant number 79747] to JM-R; research in CRAG was supported by the Spanish MINECO-FEDER [grant number BIO2017-85316-R] and AGAUR [grant number 2017-SGR1211 and Xarba] to JFM-G; the support of MINECO for the "Centro de Excelencia Severo Ochoa 2016-2019" [grant number SEV-2015-0533]; and by the CERCA Program of the Generalitat de Catalunya.

## Abbreviations

**BAP** Benzyl Amino Purine; **IAA** Indole Acetic Acid; **SGs** Steviol glycosides; **PGR** Plant growth regulators; **FS-Z** Ferralitic Soil and Zeolite; **Ch-Z** Cachaça and Zeolite, **P-Z** Peat and Zeolite, **FS-C-Z** Ferralitic soil and Cachaça and Zeolite, **FS-C-Z** Ferralitic Soil and humus and zeolite.

## References

- Abwe M.N., Ndam, L.M., Njilar, R.M., Oumar, D., Njock, T.E., Ngone, A.M., Ndam, L.M., Njilar, R.M., Oumar, D., Njock, T.E., 2021. Effective medium for *in vitro* sprouting of the buds and multiplication of the plantlets, and identification of the fungal contaminant associated with the explants of Gnetum. GSC Biological and Pharmaceutical Sciences. 16 (02), 001–013. <https://doi.org/10.30574/GSCBPS.2021.16.2.0221>
- Amien, S., Azhari, A.Z., Bakti, C., Maulana, H., 2021. The effect of shoot explant types of eleven *Stevia (Stevia rebaudiana* Bertoni) accessions on *in vitro* growth. J. Agro. 8, 142–152. <https://doi.org/10.15575/13367>
- Anbazzhagan, M., Kalpana, M., Rajendran, R., Natarajan, V., Dhanavel, D., 2010. In vitro production of *Stevia rebaudiana* Bertoni. Emirates J. Food Agric. 22, 216–222. <https://doi.org/10.9755/ejfa.v22i3.4891>
- Angelini L.G., Martini A., Passera B., Tavarini S., 2016. Cultivation of *Stevia rebaudiana* Bertoni and Associated Challenges. In: Merillon JM., Ramawat K. (eds) Sweeteners., 1-52. Reference Series in Phytochemistry. Springer, Cham. [https://doi.org/10.1007/978-3-319-26478-3\\_8-1](https://doi.org/10.1007/978-3-319-26478-3_8-1)
- Aremu, A.O., Fawole, O.A., Makunga, N.P., Masondo, N.A., Moyo, M., Buthelezi, N.M.D., Amoo, S.O., Spíchal, L., Doležal, K., 2020. Applications of cytokinins in horticultural fruit crops: Trends and Future Prospects. Biomol. 10, 1222. <https://doi.org/10.3390/BIOM10091222>
- Ashrafzadeh, S., Leung, D.W.M., 2021. Photoautotrophic micropropagation system (PAM): a novel approach deserving increased uptake for commercial plant production. Vegetos 34, 13–18. <https://doi.org/10.1007/S42535-020-00182-X>

- Azzam, C.R., Al-taweel, S.K., Abdel-Aziz, R.M., Rabea, K.M., Abou-Sreea, A.I.B., Rady, M.M., Ali, E.F., 2021. Salinity effects on gene expression, morphological, and physio-biochemical responses of *Stevia rebaudiana* Bertoni In Vitro. *Plants* 10, 820. <https://doi.org/10.3390/PLANTS10040820>
- Banerjee, M., Khursheed, R., Yadav, A.K., Singh, S.K., Gulati, M., Pandey, D.K., Prabhakar, P.K., Kumar, R., Porwal, O., Awasthi, A., Kumari, Y., Kaur, G., Ayinkamiye, C., Prashar, R., Mankotia, D., Pandey, N.K., 2019. A systematic review on synthetic drugs and phytopharmaceuticals Used to manage diabetes. *Curr. Diabetes Rev.* 16, 340–356. <https://doi.org/10.2174/1573399815666190822165141>
- Blinstrubiene, A., Burbulis, N., Juškevičiute, N., Vaitkevičiene, N., Žukiene, R., 2020. Effect of growth regulators on *Stevia rebaudiana* Bertoni callus genesis and influence of auxin and proline to steviol glycosides, phenols, flavonoids accumulation, and antioxidant activity In Vitro. *Molecules* 25 (12), 2759; <https://doi.org/10.3390/molecules251227592020>.
- Cassells, A.C., 2012. Pathogen and biological contamination management in plant tissue culture: phytopathogens, vitro pathogens, and vitro pests. *Methods Mol. Biol.* 877, 57–80. [https://doi.org/10.1007/978-1-61779-818-4\\_6](https://doi.org/10.1007/978-1-61779-818-4_6)
- Castro-González, C.G., Sánchez-Segura, L., Gómez-Merino, F.C., Bello-Bello, J.J., 2019. Exposure of stevia (*Stevia rebaudiana* B.) to silver nanoparticles in vitro: transport and accumulation. *Sci. Reports*, 1–10. <https://doi.org/10.1038/s41598-019-46828-y>
- Cioć, M.C., Tokarz, K., Dziurka, M., Zena Pawłowska, B., Paciolla, C., Villani, A., Loi, M., 2021. Energy-saving LED light affects the efficiency of the photosynthetic apparatus and carbohydrate content in *Gerbera jamesonii* Bolus ex Hook. f. Axillary shoots multiplied In Vitro. *Biol.* 10, 1035. <https://doi.org/10.3390/BIOLOGY10101035>
- Deshmukh, S.P., Patil, S.M., Mullani, S.B., Delekar, S.D., 2019. Silver nanoparticles as an effective disinfectant: A review. *Materials Science & Engineering C* 97, 954–965. <https://doi.org/10.1016/J.MSEC.2018.12.102>

- Dimitrova, N., Nacheva, L., Berova, M., Kulpa, D., 2021. Biofertilizer lumbrical improves the growth and ex vitro acclimatization of micropropagated pear plants. *Silva Balc.* 22, 17–30. <https://doi.org/10.3897/silvabalkanica.22.e57661>
- Gunasena, M.D., Senarath, W.T., 2019. In vitro plant regeneration of *Stevia rebaudiana* through indirect organogenesis. *International Journal of Botany Studies* 4 (4), 199–203. [www.botanyjournals.com](http://www.botanyjournals.com)
- Eckstein, A., Zieba, P., Gabryś, H., 2012. Sugar and light effects on the condition of the photosynthetic apparatus of *Arabidopsis thaliana* cultured in vitro. *J. Plant Growth Regul.* 31, 90–101. <https://doi.org/10.1007/s00344-011-9222-z>
- Effa, E.A., Mofunanya, A.A.J., Ngele, B.A., 2019. Influence of soil amendment on the relative growth rate and net assimilation rate of *Phaseolus vulgaris* and *Vigna aconitifolia*. *J. Appl. Life Sci. Int.* 22, 1–13. <https://doi.org/10.9734/JALSI/2019/V22I430136>
- Ghaheri, M., Kahrizi, D., Bahrami, G., Mohammadi-Motlagh, H.R., 2019. Study of gene expression and steviol glycosides accumulation in *Stevia rebaudiana* Bertoni under various mannitol concentrations. *Mol. Biol. Rep.* 46, 7–16. <https://doi.org/10.1007/s11033-018-4250-4>
- Hastoy, C., Cosson, P., Cavaignac, S., Boutié, P., Waffo-Teguo, P., Rolin, D., Schurdi-Levraud, V., 2019. Deciphering performances of fifteen genotypes of *Stevia rebaudiana* in southwestern France through dry biomass and steviol glycoside evaluation. *Ind. Crops Prod.* 128, 607–619. <https://doi.org/10.1016/j.indcrop.2018.09.053>
- Hesami, M., Naderi, R., Yoosefzadeh-Najafabadi, M., 2018. Optimizing sterilization conditions and growth regulator effects on in vitro shoot regeneration through direct organogenesis in *Chenopodium quinoa*. *BioTechnologia* 99 (1), 49–57. <https://doi.org/10.5114/bta.2018.73561>
- Heyman, L., Höfle, R., Kicherer, A., Trapp, O., Barka, E.A., Töpfer, R., Höfte, M., 2021. The durability of quantitative host resistance and variability in pathogen virulence in the interaction between

- European Grapevine cultivars and *Plasmopara viticola*. *Front. Agron.* 3, 684023. <https://doi.org/10.3389/FAGRO.2021.684023>
- Karimi, M., Ahmadi, A., Hashemi, J., Abbasi, A., Tavarini, S., Guglielminetti, L., Angelini, L.G., 2015. The effect of soil moisture depletion on Stevia (*Stevia rebaudiana* Bertoni) grown in greenhouse conditions: Growth, steviol glycosides content, soluble sugars, and total antioxidant capacity. *Sci. Hortic. (Amsterdam)*. 183, 93–99. <https://doi.org/10.1016/J.SCIENTA.2014.11.001>
- Kashefi, B., Naeimi, M., Mazaheri, E., 2020. Effect of growth regulators on optimization of Stevia (*Stevia rebaudiana*) production in vitro. *J. Med. Plants By-Products* 1, 1-8. <https://doi.org/10.22092/JMPB.2020.122068>
- Khandel, A.K., Gantait, S., Verma, S.K., 2021. Optimization of growing conditions, substrate-types and their concentrations for acclimatization and post-acclimatization growth of in vitro-raised flame lily (*Gloriosa superba* L.) plantlets. *Vegetos* 1, 1–9. <https://doi.org/10.1007/s42535-021-00297-9>
- Kim, D.H., Gopal, J., Sivanesan, I., 2017. Nanomaterials in plant tissue culture: the disclosed and undisclosed. *RSC Adv.* 7, 36492-36505. <https://doi.org/10.1039/C7RA07025J>
- Klimek-Chodacka, M., Sadlowska, K., Grzebelus, D., Baranski, R., 2015. In vitro shoots regeneration and plantlets acclimatization of *Stevia rebaudiana* Bertoni ssp. Sweetly. XIV Overall Polish in vitro Culture and Plant Biotechnology Conference *BioTechnologia* 96 (1), 119. <https://doi.org/10.5114/bta.2015.54184>
- Kumari, M., Chandra, S., 2015. Stevioside glycosides from in vitro cultures of *Stevia rebaudiana* and antimicrobial assay. *Braz. J. Bot* 38 (4), 761-770 <https://doi.org/10.1007/s40415-015-0193-3>
- Libik-Konieczny, M., Capecka, E., Tuleja, M., Konieczny, R., 2021. Synthesis and production of steviol glycosides: recent research trends and perspectives. *Appl. Microbiol. Biotechnol.* 105, 3883–3900. <https://doi.org/10.1007/S00253-021-11306-X>
- Magangana, T.P., Stander, M.A., Masondo, N.A., Makunga, N.P., 2021. Steviol glycoside content and essential oil profiles of *Stevia rebaudiana* Bertoni in response to NaCl and polyethylene glycol

- as inducers of salinity and drought stress in vitro. *Plant Cell. Tissue Organ Cult.* 145, 1–18.  
<https://doi.org/10.1007/S11240-020-01972-6>
- Mahendran D., Geetha N., Venkatachalam P., 2019. Role of silver nitrate and silver nanoparticles on tissue culture medium and enhanced the plant growth and development. In: Kumar M., Muthusamy A., Kumar V., Bhalla-Sarin N. (eds). *In vitro Plant Breeding towards Novel Agronomic Traits*. Springer, Singapore. [https://doi.org/10.1007/978-981-32-9824-8\\_4](https://doi.org/10.1007/978-981-32-9824-8_4)
- Manjusha, A.V.M., Sathyanarayana, B.N., 2010. Studies on pre acclimatization treatments to improve post acclimatization survival in *Stevia (Stevia rebaudiana Bert.)*. *Acta Hort.* 865, 171–178.  
<https://doi.org/10.17660/ActaHortic.2010.865.21>
- Matand, K., Shoemake, M., Li, C., 2020. High frequency in vitro regeneration of adventitious shoots in daylilies (*Hemerocallis* sp) stem tissue using thidiazuron. *BMC Plant Biol* 20, 31, 1–10.  
<https://doi.org/10.1186/S12870-020-2243-7>
- Mostafa, H.H.A., Wang, H., Song, J., Li, X., 2020. Effects of genotypes and explants on garlic callus production and endogenous hormones. *Sci Rep* 10, 4867. <https://doi.org/10.1038/s41598-020-61564-4>
- Murashige, T., Skoog, F., 1962. A revised medium for rapid growth and Bioassays with Tobacco tissue cultures. *Physiol. Plant.* 15, 473–497. <https://doi.org/10.1111/j.1399-3054.1962.tb08052.x>
- Nakhli, S.A.A., Delkash, M., Bakhshayesh, B.E., Kazemian, H., 2017. Application of zeolites for sustainable agriculture: a review on water and nutrient retention. *Water, Air, Soil Pollut.* 228, 464.  
<https://doi.org/10.1007/S11270-017-3649-1>
- Philippe, R.N., De Mey, M., Anderson, J., Ajikumar, P.K., 2014. Biotechnological production of natural zero-calorie sweeteners. *Current Opinion in Biotechnology* 26, 155–161.  
<https://doi.org/10.1016/J.COPBIO.2014.01.004>
- Rahman, W.A.A.W.A., Bakar, T.H.S.T.A., Kayat, F., Appalasamy, S., Zakaria, S., 2021. Effect of selected substrates and chitosan on growth performance of orchid tissue culture seedling under



- net house. IOP Conf. Series: Earth and Environmental Science 756, <https://doi.org/10.1088/1755-1315/756/1/012064>
- Rasouli, D., Werbrouck, S., Maleki, B., Jafary, H., Schurdi-Levraud, V., 2021. Elicitor-induced in vitro shoot multiplication and steviol glycosides production in *Stevia rebaudiana*. South African J. Bot. 137, 265–271. <https://doi.org/10.1016/J.SAJB.2020.10.023>
- Ribeiro, M.M., Diamantino, T., Domingues, J., Montanari, Í., Alves, M.N., Gonçalves, J.C., 2021. *Stevia rebaudiana* germplasm characterization using microsatellite markers and steviol glycosides quantification by HPLC. Mol. Biol. Rep. 48, 2573–2582. <https://doi.org/10.1007/S11033-021-06308-X>
- Röck-Okuyucu, B., Bayraktar, M., Akgun, I.H., Gurel, A., 2016. Plant growth regulator effects on In Vitro propagation and stevioside production in *Stevia rebaudiana* Bertoni. HortScience 51, 1573-1580. <https://doi.org/10.21273/HORTSCI11093-16>
- Sairkar, P., Ch, M.K., ravanshi, Shukla, N.P., Mehrotra, N.N., 2009. Mass production of an economically important medicinal plant *Stevia rebaudiana* using in vitro propagation techniques. J. Med. Plants Res. 3, 266-270. <https://doi.org/10.5897/JMPR.9000862>
- Segura-Campos, M., Barbosa-Martín, E., Matus-Basto, Á., Cabrera-Amaro, D., Murguía-Olmedo, M., Moguel-Ordo, Y., Betancur-Ancona, D., 2014. Comparison of chemical and functional properties of *Stevia rebaudiana* (Bertoni) varieties cultivated in Mexican Southeast. Am. J. Plant Sci. 2014. <https://doi.org/10.4236/ajps.2014.53039>
- Seon, J.H., Cui, Y.Y., Kozai, T., Paek, K.Y., 2000. Influence of in vitro growth conditions on photosynthetic competence and survival rate of *Rehmannia glutinosa* plantlets during acclimatization period. Plant Cell, Tissue and Organ Culture 61, 135-142. <https://doi.org/10.1023/A:1006473223286>
- Sevostyanova, E.P., Akimova, S.V., Sevostyanov, M.A., Nasakina, E.O., Korshunov, A.V., Glinushkin, A.P., 2021. Obtaining micro cuttings of potatoes by clonal micropropagation. IOP Conf.

Series: Earth and Environmental Science 663, 012061. <https://doi.org/10.1088/1755-1315/663/1/012061>

Shahzad, A., Sharma, S., Parveen, S., Saeed, T., Shaheen, A., Akhtar, R., Yadav, V., Upadhyay, A., Ahmad, Z., 2017. Historical Perspective and Basic Principles of Plant Tissue Culture. Plant In: Abdin M., Kiran U., Kamaluddin, Ali A. (eds) Plant Biotechnology: Principles and Applications. Springer, Singapore. [https://doi.org/10.1007/978-981-10-2961-5\\_1](https://doi.org/10.1007/978-981-10-2961-5_1)

Sharma, S., Kaur, I., Nagpal, A.K., 2021. Role of Plant Growth Regulators in Abiotic Stress Tolerance Chapter 10. In: Kaur, T and Arora, S. (eds). Environmental Stress Physiology of Plants and Crop Productivity Bentham Science Publishers Ltd. USA., 158-182. DOI: [10.2174/97816810879001210101](https://doi.org/10.2174/97816810879001210101)

Shekhawat, M.S., Mehta, S.R., Manokari, M., Priyadarshini, S., Badhepuri, M.K., Jogam, P., Dey, A., Rajput, B.S., 2021. Morpho-anatomical and physiological changes of Indian sandalwood (*Santalum album* L.) plantlets in ex vitro conditions to support successful acclimatization for plant mass production. Plant Cell Tiss. Organ Cult. 147, 423–435. <https://doi.org/10.1007/s11240-021-02136-w>

Stawarczyk, M., Stawarczyk, K., 2015. Use of the ImageJ program to assess the damage of plants by snails. Chemistry Didactics Ecology Metrology, 20, 63-73. <https://doi.org/10.1515/CDEM-2015-0007>

Suarez, I.E., Quintero, I.R., 2014. Micropropagación de *Stevia rebaudiana* Bertoni, un endulzante natural a través de explantes con meristemos preexistentes. Rev. Colomb. Biotecnol. 16 (1), 29–33. <https://doi.org/10.15446/REV.COLOMB.BIOTE.V16N1.29420>

Suárez, I.E., Yépez, J.E., López, C.M., 2020. Effect of different substrates on adaptation of arrow cane (*Gynerium sagittatum* Aubl.) micropropagated plants. Temas Agrarios 25 (1), 77–84. <https://doi.org/10.21897/ta.v25i1.2210>

- Sun, Y-M., Huang, X-L., Zhang, T., Yang, Y-H., Cheng, X-Y., Xu, X-Y., Yuan, H-Y., 2021. Potassium deficiency inhibits steviol glycosides synthesis by limiting leaf sugar metabolism in *Stevia rebaudiana* Bertoni plants. J. Integr. Agric. 20 (11), 2932–2943. [https://doi.org/10.1016/S2095-3119\(20\)63472-4](https://doi.org/10.1016/S2095-3119(20)63472-4)
- Thiyagarajan, M., Venkatachalam, P., 2012. Large scale in vitro propagation of *Stevia rebaudiana* (Bert) for commercial application: Pharmaceutically important and antidiabetic medicinal herb. Ind. Crops Prod. 37, 111–117. <https://doi.org/10.1016/J.INDCROP.2011.10.037>
- Trofim, M., Ciorchină, N., Mîrza, A., Tabăra, M., 2018. The influence of external factors on the development of in vitro cultured blackberry plants under ex vitro conditions. Journal of Botany 2 (17), 14-20. [CZU:634.717:58.084.1\(478\)](https://doi.org/10.1016/J.JBO.2018.08.014)
- Urbi, Z., Zainuddin, Z., 2015. Standardization of surface sterilization protocol of field grown *Stevia rebaudiana* prior to in vitro clonal propagation J. Teknologi. 77, 141–146. <https://doi.org/10.11113/jt.v77.6722>
- Xiaoying, L., Mingjuan, Y., Xiaodong, X., ABM, K., ATAK, A., Caihong, Z., Dawei, L., 2022. Effect of light on growth and chlorophyll development in kiwifruit ex vitro and in vitro. Scientia Horticulturae, 291, 110599. <https://doi.org/10.1016/j.scienta.2021.110599>
- Yadav, A.K., Singh, S., Dhyani, D., Ahuja, P.S., 2011. A review on the improvement of *Stevia rebaudiana* (Bertoni). Canadian Journal of Plant Science 91, 1–27. <https://doi.org/10.4141/cjps10086>
- Yücesan, B., Büyükgöçmen, R., Mohammed, A., Sameeullah, M., Altuğ, C., Gürel, S., Gürel, E., 2016. An efficient regeneration system and steviol glycoside analysis of *Stevia rebaudiana* Bertoni, a source of natural high-intensity sweetener. Vitro. Cell. Dev. Biol. - Plant 52, 330–337. <https://doi.org/10.1007/s11627-016-9765-6>

Zanin, G., Maucieri, C., Dal Ferro, N., Bortolini, L., Borin, M., 2020. Evaluating a controlled-release fertilizer for plant establishment in floating elements for bioretention Ponds. *Agronomy* 10(2), 199, <https://doi.org/10.3390/agronomy10020199>



**IV. CAPÍTULO III. Comparison of different *in vitro* micropropagation methods of *Stevia rebaudiana* B. including temporary immersion bioreactor (BIT<sup>®</sup>)**

Published Article

Journal Cover



ISSN: 0167-6857/1573-5044; Impact Factor 2.711



Plant Cell Tiss Organ Cult  
DOI 10.1007/s11240-017-1258-8



---

**Comparison of different *in vitro* micropropagation methods of *Stevia rebaudiana* B. including temporary immersion bioreactor (BIT<sup>®</sup>)**

Karel Vives<sup>1</sup> · Iván Andújar<sup>1</sup> · José Carlos Lorenzo<sup>1</sup> · Oscar Concepción<sup>1</sup> ·  
Martha Hernández<sup>1</sup> · Maritza Escalona<sup>1</sup>

## Abstract

*Stevia rebaudiana* is beneficial to treat diabetes because of its low-calorie glucoside sweeteners. Natural and vegetative propagation are inefficient. *In vitro* techniques are an attractive alternative but low propagation and reproducibility rates have been reported. Therefore, different ways to increase natural sweetener production *in vitro*, such as BIT<sup>®</sup>, are required. We compared semi-solid medium, liquid medium and BIT<sup>®</sup> in terms of *Stevia* biomass and steviol glycosides production. At 21 days of culture, morphological quality of BIT<sup>®</sup>-derived shoots was best and coupled with shoot fresh and dry weight that were more than seven times higher in BIT<sup>®</sup> compared with micropropagation in liquid or semisolid media. In turn, the total content of steviol glycosides produced was also higher in bioreactors. The usefulness of BIT<sup>®</sup> to produce plant metabolites *in vitro* is again demonstrated, even if additional experiments are required to increase the economic efficiency of the process.

**Keywords** Plant natural products · Steviol glycosides · Sweet grass · *In vitro* culture systems



## Introduction

*Stevia rebaudiana* (Asteraceae; sweet grass) is considered as an important medicinal plant as it possesses many beneficial effects on type II diabetes, possessing low-calorie glucoside sweeteners (Brahmachari et al. 2011). The plant contains also important natural antioxidants such as flavonoids, phenols, tannin and essential oils (Christakiet al. 2013).

Natural propagation of *Stevia* is restricted by the low viability of seeds due to self-incompatibility, which causes the production of sterile seeds. Vegetative propagation is also limited to a low number of individuals that may be obtained from a single plant and successfully adapted to the soil (Carneiro et al. 1997). A large number of plants from an ideal cum better-quality genotype using a desirable explant could be harvested by employing *in vitro* culture system and it has been proved smart propagation to preserve the uniformity within short culture duration (Sivanandhan et al. 2015).

*Stevia rebaudiana* micropropagation protocols have been reported by different authors

(Ramírez-Mosqueda et al. 2016), who generally found low propagation and reproducibility rates. On the other hand, different studies have emphasized the need for techniques that allow efficient *in vitro* stevioside and rebaudioside yields (Suarez and Quintero 2014). A production comparative analysis of these compounds in *in vivo* plants, *in vitro*-plants, dedifferentiated calluses, cell suspensions and regenerated shoots has shown identical qualitative composition. However, steviol glycosides content in *in vitro* cultured material has been five to six times lower than in field growth plants (Bondarev et al. 2001). The use of elicitors have been used to increase steviosides production, *in vitro* shoot growth, and biomass accumulation in micropropagated *S. rebaudiana* (Bayraktar et al. 2016) as well as *Agrobacterium* mediated hair root cultures to steviol glycosides production (Pandey et al. 2016). Therefore, alternative ways to increase natural sweetener production *in vitro*, such as BIT<sup>®</sup>, are required.

Several authors have reported the use of bioreactors to increase production of biomass and plant chemical compounds: e.g. phenolics in sugarcane (Lorenzo et al. 2001), proteases in pineapple (Perez et al. 2004), cardiotoxic glycosides in *Digitalis purpurea* L. (Pérez-Alonso et al. 2009), proteins in *Nicotiana tabacum* (Michoux et al. 2013), steroids in *Withania somnifera* (Sivanandhan et al. 2014) and alkaloids in plants of the family *Amaryllidaceae* (Georgiev et al. 2014). In *S. rebaudiana*, Alvaréngua-Venutolo and Salazar-Aguilar (2015) and Ramírez-Mosqueda et al. (2016) have conducted studies about the use of RITA<sup>®</sup>; a design of BIT<sup>®</sup> different from the one used here; but endogenous levels of steviol glycosides produced *in vitro* were not reported. Compared to RITA<sup>®</sup>, BIT<sup>®</sup> allows more gas exchange and is more flexible to be scaled-up, e.g., from 250 mL to 20 L (Escalona et al. 1999, 2003). The present study compared three *in vitro* culture methods: semisolid medium, liquid medium and BIT<sup>®</sup>, in terms of the production of *S. rebaudiana* B. biomass and steviol glycosides content.

## Material and Methods

*In vitro* culture establishment of cv. Morita II was implemented according to Espinal de Rueda et al. (2006). Nodal segments from greenhouse mother plants were disinfected with sodium hypochlorite (1% v: v) for 5 min; washed threetimes with sterile distilled water; and cultivated in solid Murashige and Skoog (1962) salts medium supplemented with 30 g·L<sup>-1</sup> sucrose, 100 mg·L<sup>-1</sup> myo-inositol and 1 mg·L<sup>-1</sup> thiamine for 21 days. Nodal segment multiplication was performed in the same, semisolid, medium containing in addition agar 6 g·L<sup>-1</sup> and 0.25 mg·L<sup>-1</sup> benzyl amino purine. At 7th subculture age of nodal segment multiplication, with sub-cultures every 21 days, homogeneous nodal segments were selected to initiate the experiments.

Nodal segments (1 cm) with two axillary buds were cultivated either on semisolid (Fig. IV.1a) or liquid medium (Fig. IV.1b), or BIT<sup>®</sup> (Fig. IV.1c). Each culture method involved three replicates of 20 nodal segments (total: 60 segments/ method). Each 1000 ml glass flask contained 250 mL medium (i.e., 12.5 ml/explant). Multiplication medium was the same as above and cultures were maintained under fluorescent cold light (80  $\mu\text{mol m}^{-2} \text{s}^{-1}$ , 16 h per day) at  $28 \pm 2$  °C. At 21 days of culture, the indicators measured were: number of leaves per shoot; shoot number per explant; number of internodes per shoot formed; shoot length (cm), total fresh and dry weight per culture container (g). Water content of plant material (%) was calculated  $WC = (FW - DW)/FW \times 100$ ; and steviol glycosides content measured. To measure steviol glycosides levels, the protocol by Vázquez-Baxcajaj et al. (2014) was followed. Briefly, shoots were oven-dried (HS 62A) at 65 °C for 72 h, then milled in a Micro-Feinmuhle-Culatti mill at 500 rpm to 0.7 mm particle diameter. For extraction, 90% ethanol (2 mL per 0.2 g of dry plant material) was used. The extraction mixture was shaken for 2 h at room temperature. homogenate was centrifuged at 8000×g for 10 min and the supernatant was collected for steviol glycosides quantification. To quantify steviol glycosides content, the absorbance at 210 nm was recorded. Steviol glycosides content was referred to a calibration curve (1 mg·mL<sup>-1</sup>). Steviol glycoside content was expressed as mg/g dry weight (DW); mg·g<sup>-1</sup> fresh weight (FW) and steviol glycosides total g produced (Kolb et al. 2001). Middle-aged leaves of greenhouse-grown *S. rebaudiana* plants (0.5-year-old) were also sampled and analyzed.



### Stevioside and rebaudioside analysis A cuantification by HPLC

To quantify the levels of Rebaudioside A ( $\geq 96\%$  HPLC), and Stevioside standards ( $\geq 98\%$  HPLC), acquired from Sigma Aldrich, St. Louis, Missouri, USA. A. Chromatographic method was carried out under isocratic conditions in a Varian System (Darmstadt, Germany), consisting of a Pro Star 230 pump, a 335-diode array detector set to a wavelength of 210 nm. A Luna HILIC analytical column (250 x 4.6 mm, 5  $\mu\text{m}$  particle size, Phenomenex, Aschaffenburg, Germany) was used to analyze stevioside and rebaudioside A. The mobile phase consisted of acetonitrile: water (85:15, v: v) adjusted to a flow rate of  $1.0 \text{ mL}\cdot\text{min}^{-1}$  maintained at  $25^\circ\text{C}$ .

### Statistical analysis

The *in vitro* culture experiment, in a completely randomized design, was repeated three times and representative data are shown here, while steviol glycoside quantification was repeated nine times. SPSS (version 20.0) was used to perform One-Way ANOVA and Tukey ( $\alpha = 0.05$ ). Previously, normal distribution and homogeneity of variances were also demonstrated according to Kolmogorov–Smirnov ( $\alpha = 0.05$ ) and Levene ( $\alpha = 0.05$ ) tests, respectively. For the statistical analysis only, discrete variables (leaves and inter-nodes number) were transformed according to  $y' = y^{0.5}$ .

### Result and Discussion

On 21st day of culture, multiple shoots grew in temporary immersion bioreactor, BIT<sup>®</sup> exhibited greater morpho-logical features such as better expanded or larger leaves, taller shoots or shorter nodal segments and green intense color (Fig. IV.1d). Several statistically significant differences were observed in quantitative data (Table IV.1). Dry weight (mg/g) and total dry weight (g) per container in temporary immersion bioreactor, BIT<sup>®</sup> were remarkably higher (around 9.6–6.6 times) when compared to liquid and semi- solid culture methods respectively. The total steviol glyco- sides content ( $\text{mg}\cdot\text{g}^{-1}$ ) did not differ significantly between semisolid and BIT<sup>®</sup> culture, however a higher production (0.169 g per container) was obtained in the BIT<sup>®</sup> due to the greater accumulation of plant material produced.

BIT<sup>®</sup> clearly increased total fresh weight expressed as shoots with higher size leaves and steviol glycosides content (Table IV.1). These results might be due to the efficacy of BIT<sup>®</sup> that combine ventilation of the plant tissues with intermittent contact between the entire surface of the tissue and the liquid medium. These two characteristics are not usually combined in other liquid and semisolid culture procedures (Berthouly and Etienne 2005). On the other hand, in BIT<sup>®</sup>, there is a direct contact of the culture medium with the leaves, leading to the possibility of nutrient uptake by them, unlike in semisolid medium (Escalona et al. 1999,2003; Ziv 2005).

**Table. IV.1.** Effects of culture methods on multiplication and contents of steviol glycosides at 21 days of culture

	Liquid culture medium	Semisolid culture medium	Temporary immersion bioreactor
Number of leaves per nodal segment (n=20)	15.0±0.9 b	19.0±0.8 a	17.0±0.6 a
Shoot number per nodal segment (n=20)	2.0±0.1 b	4.0±0.2 a	5.0±0.3 a
Number of internodes per shoot formed (n=20)	6.5±0.4 b	8.6±0.6 a	10.3±0.9 a
Shoot length (n=20) (cm)	4.7±0.3 b	5.0±0.2 b	7.4±0.5 a
Total fresh weight per container (n=3) (g)	5.1±0.2 b	5.5±0.5 b	35.9±2.8 a
Total dry weight per container (n=3) (g)	0.50±0.03 b	0.60±0.01 b	3.91±0.21 a
Shoot water content (n=3) (%)	90.1±8.3 b	80.3±6.5 a	80.5±5.4 a
Steviol glycosides content			
mg/g dry weight (DW) (n=3)	35.30±2.36 c	40.05±2.78 b	43.40±3.11 a
mg/g fresh weight (FW) (n=3) *	3.46±0.25 c	4.36±0.34 b	4.73±0.12 a
Total g per container (n=3)	0.0176±0.0008 b	0.0239±0.0011 b	0.1698±0.0019 a

Results with the same letter are not statistically different (One Way ANOVA, Tukey,  $P > 0.05$ ). For statistical analysis only, the number of leaves, shoots and internodes were transformed according to  $y' = y^{0.5}$

\*In greenhouse-grown *S. rebaudiana* plants (0.5-year-old), content of steviol glycosides in middle-aged leaves reached  $7.65 \pm 0.55$  (SE) mg/gFW (7.65%)

Steviol glycosides content in leaves and stems of three *Stevia* clones was reported by Bondarev et al. (2001). They found marked differences between *in vivo* and *in vitro* culture produced tissues (callus, cell suspension culture, morphogenetic callus and shoots regenerated from callus). Steviol glycosides qualitative composition in *in vitro* plants was found to be identical to that of *in vivo* plants, but their content appeared to be about five or six times lower. The stevioside content of field-grown plants was identified as  $15.06 \text{ mg} \cdot \text{g}^{-1} \text{ DW}$  (Bayraktar et al. 2016). However, steviol glycoside content

for cv. Morita II shoots achieved in BIT<sup>®</sup> culture in this study was two times higher than previously reported by Bayraktar et al. (2016).

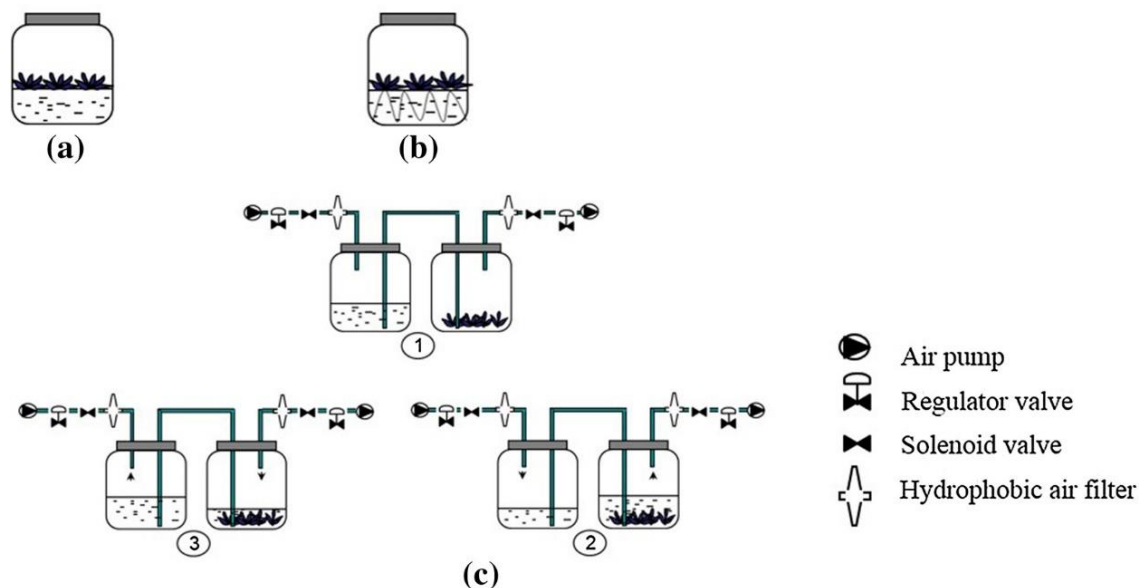

**Fig. IV.1** Design of plant culture methods and typical phenotype of shoots produced. Glass size container used for micropropagation (1000 ml) and 250 ml culture medium volume (12.5 ml medium/explant) for each culture method assayed. Nodal segments number 20 explants. **a** Micropropagation on semisolid medium. **b** Micropropagation in liquid medium, with shoots maintained on filter paper supports. **c** Operating cycle of BIT<sup>®</sup>. (1) non-immersed stage, shoots were free-standing on the bottom of the culture vessel. (2) Beginning of the immersed stage; an overpressure was applied and the medium was pushed up into the plant container, immersing the shoots for 3 min. (3) End of the immersed stage, a second solenoid valve was opened and the culture medium was removed into the reservoir. These steps were performed every 6 h. The air pump and electric valves were under control of a timer (Escalona et al. 1999, 2003).

We have quantified the content of stevioside and rebaudioside A in plants of *S. rebaudiana* cv. Morita II, in the three propagation methods evaluated (solid; liquid; BIT). Fig. IV.2 shows the content of stevioside and rebaudioside A comparing the representative contents in each culture method evaluated. We found a notable change in the relative abundance of stevioside and rebaudioside A in plants grown for 21 days in BIT compared to the solid and liquid micropropagation methods (Fig. IV.2).

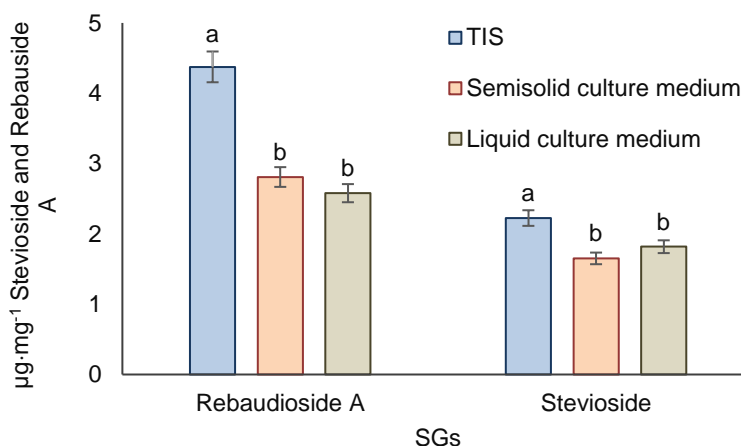

**Fig. IV.2** Levels of stevioside and rebaudioside A in extracts of leaves from *S. rebaudiana* cultivar Morita II ( $\text{mg}\cdot\text{mg}^{-1}$  of dry weight), Grown for 21 days under three different propagation methods (BIT; Semisolid medium and Liquid Medium). Results with the same letter are not statistically different (One Way ANOVA, Tukey,  $P < 0.05$ ,  $n = 5$ ).

The highest contents of rebaudioside A and stevioside ( $4.37$  and  $2.22 \mu\text{g}\cdot\text{mg}^{-1}$  of dry weight) were reached in plants grown in BIT. While the treatments of plants grown in liquid and semi-solid medium did not show significant differences between them. Our results are similar to those obtained by Villamarín et al., 2020, they study the effect of inoculation with *T. asperellum* on the growth and accumulation of steviol glycosides and phenolic compounds and obtain better growth and a higher content of steviol glycosides for plants propagated under these conditions.

The BIT that showed the best results in terms of plant elongation, number of leaves, and almost all the morphological traits evaluated (Fig IV.3). This is due to the properties of a vertical container, the space between the explants and the upper part of the container is greater compared to the other cultivation methods evaluated. This allows a greater availability of gases and space for the elongation of the explants, and thus also promoting a greater metabolic activity with regard to the production of stevioside and rebaudioside A. The immersion systems evaluated will allow scaling-up and, therefore, obtaining a greater number of plants compared with the conventional semi-solid or liquid system. We obtained with the BIT system a greater sprouting and shoot length in the cultivar 'Morita II and also a higher SGs production.



**Fig IV.3.** Typical phenotype of *S. rebaudiana* shoots grown for 21 days under three different propagation methods (BIT; Semisolid medium and Liquid Medium).

## Conclusions

The environmental conditions in BIT<sup>®</sup> have been previously reported to have a crucial influence on plant growth, physiology, and carbon metabolism in plantain leaves (Aragón et al. 2014), due to the continuous renewal of the atmosphere surrounding the plantlets which favors auto-trophic nutrition, growth and production of secondary metabolites such as steviol glycosides. The experiments shown here demonstrate again this usefulness of BIT<sup>®</sup> to produce plant metabolites *in vitro*, although additional experiments are required in the particular case of *S. rebaudiana* to increase biomass production and formation of natural sweeteners. Such photomixotrophic culture studies using BIT<sup>®</sup> to increase biomass production levels of *S. rebaudiana* cv: Morita II are underway.

**Acknowledgements** This research was supported by the Bioplant Center (University of Ciego de Ávila, Cuba, PN-107). We are grateful to Ms. Yarianne Lezcano and Mr. Noel González for their skilled technical assistance.

**Author contributions** KV, IA, MH, JCL, OC and ME designed the research and wrote the paper; KV and IA conducted the experiments and analyzed the data; KV and ME had primary responsibility for the final content. All authors have read and approved the final manuscript.

## References

- Alvarenga-Venutolo S, Salazar-Aguilar T (2015) Mass micropropagation of *Stevia rebaudiana* Bertoni in temporary immersion systems. *Cult Trop* 36:50–57
- Aragón C, Sánchez C, Gonzalez-Olmedo J, Escalona M, Carvalho L, Amâncio S (2014) Comparison of plantain plantlets propagated in temporary immersion bioreactors and gelled medium during in vitro growth and acclimatization. *Biol Plant* 58:29–38
- Bayraktar M, Naziri E, Hakki I, Fatih A, Esra K, Begum I, Erdal A, Gurel BA (2016) Elicitor induced stevioside production, in vitro shoot growth, and biomass accumulation in micropropagated *Stevia rebaudiana*. *Plant Cell Tiss Org Cult* 127:289–300
- Berthouly M, Etienne H (2005) Temporary immersion system: a new concept for use liquid medium in mass propagation. *Liquid culture systems for in vitro plant propagation*. Springer, New York, pp 165–195
- Bondarev N, Reshetnyak O, Nosov A (2001) Peculiarities of diterpenoid steviol glycoside production in vitro cultures of *Stevia rebaudiana* Bertoni. *Plant Sci* 161:155–163
- Brahmachari G, Mandal LC, Roy R, Mandal S, Brahmachari AK (2011) Stevioside and related compounds - molecules of pharmaceutical promise: a critical overview. *Arch Pharm* 344:5–19
- Carneiro J, Muniz A, Guedes T (1997) Greenhouse bedding plant production of *Stevia rebaudiana* (Bert) bertoni. *Can J Plant Sci* 77:473–474
- Christaki E, Bonos E, Giannenas I, Karatzia MA, Florou-Paneri P (2013) *Stevia rebaudiana* as a novel source of food additives. *J Food Nut Res* 52:167–178
- Escalona M, Lorenzo JC, González B, Daquinta M, Borroto C, González JL, Desjardines Y (1999) Pineapple micropropagation in temporary immersion systems. *Plant Cell Rep* 18:743–748
- Escalona M, Samson G, Borroto C, Desjardins Y (2003) Physiology of effects of temporary immersion bioreactors on micro-propagated pineapple plantlets. *In Vitro Cell Dev Biol-Plant* 39:651–656
- Espinal de Rueda D, Delvalle W, Cifuentes E, Ramia N (2006) Propagación in vitro de *Stevia rebaudiana* B. a partir de segmentos nodales. *Ceiba* 47:11–18

- Georgiev V, Ivanov I, Berkov S, Pavlov A (2014) Temporary immersion systems for *Amaryllidaceae* alkaloids biosynthesis by *Pan- cratium maritimum* L. shoot culture. *JPBBio* 23:389–398
- Kolb N, Herrera J, Ferreira D, Uliana R (2001) Analysis of sweet diterpene glycosides from *Stevia rebaudiana*: improved HPLC method. *J Agric Food Chem* 49:4538–4541
- Lorenzo JC, Blanco MA, Peláez O, González A, Cid M, Iglesias A, González B, Escalona M, Espinosa P, Borroto C (2001) Sugar- cane micropropagation and phenolic excretion. *Plant Cell Tiss Org Cult* 65:1–8
- Michoux F, Ahmad N, Hennig A, Nixon P, Warzecha H (2013) Production of leafy biomass using temporary immersion bioreactors: an alternative platform to express proteins in transplastomic plants with drastic phenotypes. *Planta* 237:903–908
- Murashige T, Skoog F (1962) A revised medium for rapid growth and bioassays with tobacco tissue culture. *Physiol Plant* 5:473–497
- Pandey H, Pandey P, Pandey SS, Singh S, Banerjee S (2016) Meeting the challenge of stevioside production in the hairy roots of *Stevia rebaudiana* by probing the underlying process. *Plant Cell Tiss Org Cult* 126:511–521
- Perez A, Napoles L, Carvajal C, Hernandez M, Lorenzo JC (2004) Effect of sucrose, inorganic salts, inositol and thiamine on protease excretion during pineapple culture in temporary immersion bioreactors. *In Vitro Cell Dev Biol-Plant* 40:311–316
- Pérez-Alonso N, Wilken D, Gerth A, Jähn A, Nitzsche H, Kerns G, Capote-Perez A, Jiménez E (2009) Cardiotonic glycosides from biomass of *Digitalis purpurea* L. cultured in temporary immersion systems. *Plant Cell Tiss Org Cult* 99:151–156
- Ramírez-Mosqueda M, Iglesias-Andreu L, Ramírez-Madero G, Hernández-Rincón E (2016) Micropropagation of *Stevia rebaudiana* Bert. in temporary immersion systems and evaluation of genetic fidelity. *South Afr J Bot* 106:238–243
- Sivanandhan G, Selvaraj N, Ganapathi A, Manickavasagam M (2014) Enhanced biosynthesis of withanolides by elicitation and precursor feeding in cell suspension culture of *Withania somnifera* (L.) Dunal in shake-flask culture and bioreactor. *PLoS ONE* 9: e104005

- Sivanandhan G, Vasudevan V, Selvaraj N, Lim YP, Ganapathi A (2015) L-Dopa production and antioxidant activity in *Hybanthus enneaspermus* (L.) F. Muell regeneration. *Physiol Mol Biol Plants* 21:395–406
- Suarez IE, Quintero IR (2014) Micropropagation of *Stevia rebaudiana* Bertoni, a natural sweetener, through preexisting meristem explants. *Rev Col Biotechnol* 16:29–33
- Vázquez-Baxcajaj L, Robledo-Paz A, Muratalla-Lúa A, Conde-Martínez V (2014) Micropropagación de *Stevia rebaudiana* Bertoni y detección de esteviósidos. *Bioagro* 26:49–56
- Villamarín-Gallegos, D., Oviedo-Pereira, D.G., Evangelista-Lozano, S., Sepúlveda-Jiménez, G., Molina-Torres, J., Rodríguez-Monroy, M., 2020. *Trichoderma Asperellum*, an inoculant for production of steviol glycoside in *Stevia Rebaudiana* Bertoni plants micropropagated in a temporary immersion bioreactor. *Rev. Mex. Ing. Química* 19, 1153–1161
- Ziv M (2005) Simple bioreactors for mass propagation of plants. *Liquid Culture Systems for in vitro Plant Propagation*. Springer, Dordrecht, pp 79–93.

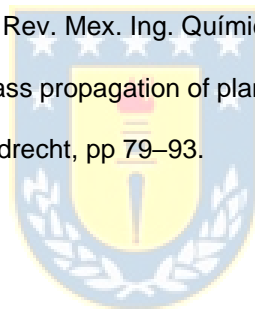



## V. DISCUSIÓN GENERAL

La *Stevia rebaudiana* (Bertoni) Bertoni (Asteraceae) es una planta modelo, ideal para el estudio de patrones de glicosilación en metabolitos especializados tipo terpenos, no sólo porque sus hojas acumulan más de 30 tipos de SGs sino también por su corto ciclo de crecimiento y fácil reproducción (Petit et al., 2020).

*Stevia* es única debido a la producción de SGs, que son metabolitos especializados pertenecientes al grupo diterpenoides y que comparte ruta biosintética similar a los de las giberelinas (GA). Las GA son esencial para el crecimiento y desarrollo normal de las plantas, y los genes implicados en la vía de biosíntesis de GA se conservan y regulan estrictamente en plantas superiores (Li et al., 2021). Parece que la biosíntesis de SGs y GA deberían estar espacial o temporalmente separadas; para evitar perturbar la normalidad del metabolismo de GAs<sup>12</sup>; sin embargo, la síntesis de SGs y los mecanismos de separación de los mismos con respecto a la biosíntesis de GA en *Stevia* continúan siendo una de las piedras rosetas del metabolismo secundario de terpenos en esta especie (Kurze et al., 2021).

El contenido de SGs está en parte determinado por la genética de los diversos cultivares de *S. rebaudiana* (Tavarini et al., 2018). Para analizar en qué medida la expresión de genes relacionados con las principales enzimas de la ruta metabólica de SGs difiere entre aspectos genéticos y cómo afecta la acumulación de SGs, se estudió el contenido de esteviósido y rebaudiósido A en hojas de los cultivares de *S. rebaudiana* Morita II y Criolla, que de los más conocidos y cultivados. De acuerdo con investigaciones previas, Morita II presenta un alto contenido de SGs, particularmente rebaudiósido A (Aranda-González et al., 2015; González-Chavira et al., 2018; Abdelsalam et al., 2019). Específicamente en nuestro estudio, comparamos los cultivares Morita II y Criolla, en la misma edad fisiológica y bajo las mismas condiciones ambientales crecidas en invernaderos, los niveles de Rebaudiósido A fueron 9,69 veces superiores a los producidos por el cultivar Criolla. Es importante destacar que la gran cantidad de rebaudiósido A en el cultivar Morita II fue específica para este SGs,

ya que los niveles de esteviósido no fueron tan altos; de hecho, la concentración de esteviósido fue 3.4 veces menor en el cultivar Morita II que en el cultivar Criolla.

Decidimos evaluar los niveles de expresión génica de *SrKA13H*, que codifica para la enzima KA13H, extremadamente clave y responsable de formar el esqueleto base aglicona (esteviol) y favorecer la posterior síntesis de SGs, metabolito a partir del cual se diversifica la ruta de los SGs (Fig. II.1). Por tanto, para favorecer la producción de SGs, es necesaria la síntesis de esteviol. Se ha reportado que la sobreexpresión de *SrKA13H* puede conducir a la acumulación de esteviol como ocurre cuando se sobre expresa en *E. coli* (Wang et al., 2016; Moon et al., 2020).

Mediante el uso de ensayos *in vitro* e *in vivo*, se estableció la naturaleza promiscua de las enzimas UGT74G1 y UGT76G1, que mostraron una especificidad de sustrato más amplia, catalizando la formación de una variedad de productos, lo que aporta una mayor complejidad a la regulación del metabolismo de los SGs (Richman et al., 2005; Wu et al., 2020). Por lo tanto, estas enzimas pueden contribuir a la síntesis tanto del esteviósido como del rebaudiósido A. Al comparar la transcripción de estos genes entre cultivares, todos presentaron niveles más altos de expresión en el cultivar Morita II que en la Criolla. La naturaleza promiscua de UGT74G1 y UGT76G1 se podría relacionar con que los niveles de rebaudiósido A y no los de esteviósido fueran más altos en Morita II. Además, el esteviósido puede ser sustrato de UGT76G1 para generar el rebaudiósido A. La mayor diferencia de expresión entre los dos cultivares se observó en *SrUGT76G1*, esto concuerda con la alta actividad que conduce a la síntesis del rebaudiósido A, al consumirse esteviósido. Cuando *SrUGT76G1* se expresa en niveles bajos, el esteviósido se puede acumular como ocurre en el cultivar Criolla, lo que resulta en un mayor contenido de esteviósido que el rebaudiósido A, como se describió anteriormente (Angelini y Tavarini, 2014).

No solo las condiciones genéticas, sino también ambientales y de crecimiento pueden afectar la síntesis de SGs. Entre los diferentes factores abióticos, el efecto de la luz sobre la producción de SGs ha sido abordado por diferentes autores (Ceunen et al., 2012; Ceunen y Geuns, 2013a, 2013b; Jarma-Orozco et al., 2020; Shulgina et al., 2021; Yoneda et al., 2017a, 2017b). Estos trabajos

abordan diferentes aspectos como la intensidad lumínica y la calidad de la luz. En nuestro trabajo analizamos el efecto de la intensidad de la luz teniendo en cuenta: (1) los posibles efectos negativos provocados por un exceso luz, evitando esto se seleccionó intensidades de luz por debajo del punto de saturación de lumínica; (2) que la etapa de desarrollo fisiológico sea lo más homogénea posible puede influir en el contenido de SGs (Ceunen y Geuns, 2013b), por lo cual los diferentes tratamientos lumínicos se aplicaron durante 15 días al cultivar Morita II, y (3) cómo las diferentes intensidades de luz pueden afectar la expresión génica de las enzimas biosintéticas de SGs más abundantes (*SrHA13H*, *SrUGT74G1*, *SrUTG76G1*) y su correlación con la composición de esteviósido y rebaudiósido A.

La actividad de las enzimas KO y KA13H requiere el apoyo de una citocromo P450 reductasa (CPR) dependiente de NADPH para convertir ent-kaureno en ácido ent-kaurenoico y finalmente en esteviol (Fig. II.1) (Zhou et al., 2021; Ko y Woo, 2021). Al reconstruir la vía de las SGs en *E. coli*, se ha demostrado que el ácido ent-kaurenoico se acumula a mayores niveles de NADPH (Moon et al., 2020). Por lo tanto, podemos especular que la actividad de estas enzimas dependientes de NADPH dependerá de la fotosíntesis. Con tasas de fotosíntesis más altas, se espera que la actividad promovida del módulo KO-CPR-KA13H pueda favorecer la acumulación de esteviol, que a su vez puede estimular las siguientes reacciones de glicosilación para producir SGs. Esto se vincula con nuestros resultados en los que, el contenido de SGs aumentó al mismo tiempo que se intensificó la luz (Fig. II.5F). Se desconoce si la planta se beneficia de la acumulación de SG en condiciones de mucha luz.

A mayor intensidad lumínica  $900 \mu\text{mol}\cdot\text{m}^{-2}\cdot\text{s}^{-1}$  se observó un incremento en la producción de SGs Aunque aumentó los niveles totales de estos metabolitos, la proporción de esteviósido también fue la más alta. Sin embargo, aunque los niveles de rebaudiósido A fueron significativamente más altos a mayor intensidad de luz, la proporción de rebaudiósido A esteviósido fue la más baja. Este es un aspecto importante a considerar cuando se utilizan SGs como edulcorantes naturales, debido al amargor del esteviósido. El tipo de SGs sintetizados se puede relacionar con la expresión de las enzimas biosintéticas. Varios trabajos han observado que la expresión de *SrKA13H*, *SrUGT74G1* y

*SrUGT76G1* cambia en diferentes condiciones ambientales como la salinidad (Lucho et al., 2019), o bajo el efecto de diferentes elicitores como ácido salicílico, quitosano y peróxido de hidrógeno (Vazquez et al., 2019). Yoneda et al. (2017b) estudiaron la interacción de diferentes tratamientos de luz y la expresión de enzimas biosintéticas de SGs en *S. rebaudiana*. Aunque este trabajo también evaluó diferentes intensidades de luz, los cambios más importantes en la expresión génica y la acumulación de SGs se observaron cuando se aplicaron tratamientos con luz roja, roja lejana y al final del día con luz roja lejana. Otros autores también han informado del aumento del contenido de SGs al complementar con luz roja o roja lejana (Ceunen et al. 2012; Shulgina et al., 2021). Desafortunadamente, este trabajo no evaluó los contenidos de SGs bajo diferentes intensidades de luz. Además, la biomasa de *S. rebaudiana* fue muy diferente bajo los tratamientos estudiados, lo que también se describe en estudios donde se evalúan fotoperiodos largos (Ceunen y Geuns, 2013a, 2013b).

En nuestro estudio, la expresión de genes *SrKA13H*, *UGT74G1* y *UGT76G1* aumentó a intensidades de luz más altas. Sin embargo, no se puede afirmar que las cantidades de esteviósido y rebaudiósido A producidas a diferentes intensidades de luz evaluadas dependan exclusivamente de la mayor expresión de un gen con respecto al otro. Por ejemplo, a niveles de intensidad de luz media y alta, no se observaron diferencias significativas en la expresión de *SrKA13H* y *SrUGT76G1*. Sin embargo, se observó una mayor producción de rebaudiósido A. Esto se puede explicar por la mayor expresión de la enzima *SrUGT74G1* junto con las intensidades de luz crecientes que se corresponde con una acumulación de esteviósido, también actúa como un precursor del rebaudiósido A. Por lo tanto, para aumentar los niveles de rebaudiósido A y obtener extractos con más dulzor, no sólo es necesario incrementar su enzima biosintética directa, sino también otras involucradas en los pasos previos de la vía.

La micropropagación de plantas con rasgos deseables ha sido una piedra angular del desarrollo social a lo largo de la historia. Su aplicación tecnológica actual va desde el uso de plantas ornamentales, agrícolas y medicinales, con aplicación en la agricultura y la industria farmacéutica (Banerjee et al., 2019). Uno de los edulcorantes más reservados biológicamente y bajos en calorías

son los obtenidos de las hojas de *S. rebaudiana*, que ha generado su cultivo extensivo a nivel mundial para producir SGs como el esteviósido y el rebaudiósido A, metabolitos especializados con un dulzor de 250 a 450 veces mayor que el de la sacarosa (Sun et al., 2021).

El cambio en las plantas de condiciones *in vitro* a condiciones de invernadero *ex vitro* es crucial y significa que las plantas pasan por un período de aclimatación para sobrevivir (Klimeket al., 2015). Durante esta etapa, las plantas se ven obligadas a formar nuevas raíces funcionales y pasar a ser completamente fotoautótrofas (Shekhawat et al., 2021). El éxito de la etapa de aclimatación está condicionado por factores como la humedad, el tipo y calidad del sustrato, la temperatura y el manejo agronómico (Khandel et al., 2021). Uno de los principales indicadores a evaluar en la etapa de aclimatación es la tasa de supervivencia (Seon et al., 2000).

Se han realizado considerables esfuerzos para optimizar las condiciones de transición cultivo *in vitro* a *ex vitro* en plantas de *S. rebaudiana*. Sin embargo, aún son escasos los estudios del proceso de aclimatación, etapa fundamental para el desarrollo exitoso de un protocolo completo de micropropagación (Angelini et al., 2016). Manjusha y Sathyanarayana (2010) evaluaron la inmersión de brotes de *S. rebaudiana* en soluciones a diferentes concentraciones de BAP en la etapa de aclimatación y observaron que el uso de  $3 \text{ mg} \cdot \text{L}^{-1}$  resultó en un mayor número de brotes, aumentaron otros parámetros de crecimiento promedio y el porcentaje de supervivencia 75.80%, 25.29% más que el testigo, que fue 60.50%. Mayores niveles de supervivencia (92%) se obtuvieron en nuestro estudio en brotes de *S. rebaudiana* cv. Morita II cultivados sobre el sustrato formulado por turba y zeolita 1: 1 (v: v) (Tabla III.3).

En nuestra investigación, se estudió la influencia que podría tener el tránsito de las plantas cultivadas en condiciones foto-mixotróficas (*in vitro*) a condiciones foto-autotróficas (etapa de aclimatación *ex vitro*) sobre la expresión génica relativa de las principales enzimas de la vía metabólica, así como en la producción de esteviósido y rebaudiósido A. Para lograr una mayor producción de SGs *in vitro*, varios autores han estudiado cómo aumentar los niveles de expresión génica de las principales enzimas de la vía metabólica de los SG, mediante el uso de elicitores

osmóticos como NaCl y manitol en ambientes *in vitro* (Ghaheri et al., 2019). Observaron que el tratamiento de control mostró los niveles de expresión más altos con respecto al aumento de las concentraciones de NaCl. Por otro lado, los estudios sobre el efecto de diferentes concentraciones de manitol favorecieron, en algunos casos, el aumento diferencial de genes como *SrUGT74G1*, mientras que la expresión de otros como *SrUGT76G1* no difirió significativamente (Azzam et al., 2021).

En nuestro estudio la expresión génica relativa de *SrKAH13*, *SrUGT74G1* y *SrUGT76G1* fueron similares a las obtenidas por estos autores en el tratamiento control, resultado relacionado con el hecho de que en nuestro protocolo no se utilizaron elicitores para provocar la sobreexpresión de genes o producción de SG en condiciones *in vitro*. En cuanto al contenido de esteviósido y rebaudiósido A, los porcentajes reportados por estos trabajos son inexactos. En nuestro trabajo, los brotes de *S. rebaudiana* cultivados durante la etapa de enraizamiento *in vitro* durante 30 días mostraron bajos niveles de expresión génica y bajos contenidos de esteviósido y rebaudiósido A.

De acuerdo con el contenido de esteviósido y rebaudiósido A, se observó una diferencia significativa entre las plantas *ex vitro* (cultivadas en la mezcla de sustrato turba más zeolita) en comparación con las plantas en la fase de enraizamiento *in vitro*. En la mayoría de los sistemas de propagación *in vitro*, el flujo de fotones fotosintéticos típico es alrededor de  $40 \mu\text{mol}\cdot\text{m}^{-2}\cdot\text{s}^{-1}$ , diez veces más bajo que los niveles de luz en ambientes *ex vitro*. En un entorno de menor energía, que incluye menor capacidad de síntesis de ATP y menor poder reductor (NADPH), se reduce la acumulación de biomasa. La baja capacidad de fijación de carbono tiende a reflejarse durante la aclimatación, con una probabilidad adicional de fotoinhibición cuando los mecanismos de foto-protección están subdesarrollados. (Singh et al., 2017; Neto et al., 2020).

Como novedad, en nuestro estudio observamos que, al comparar plantas cultivadas durante 30 días en la etapa de enraizamiento en medio MS con plantas cultivadas por el mismo tiempo en una mezcla de sustrato de turba y zeolita durante la etapa de aclimatación, se produjo un cambio considerable con respecto a la expresión relativa de los genes *SrKAH13* y *SrUGT76G1*, siendo

significativo el incremento 30 días después de estar en aclimatación (Fig. III.6). Por otro lado, aunque se observó una diferencia significativa en la expresión de *SrUGT74G1* entre plantas *in vitro* y *ex vitro*, la expresión de este fue el más bajo. El aumento en la expresión relativa de los genes *SrKAH13*, *SrUGT74G1* y *SrUGT76G1* y la producción de esteviósido y rebaudiósido A, comparadas con plantas cultivadas *in vitro* durante el enraizamiento, indica que las plantas producen un alto contenido de estos compuestos en un corto período de tiempo al pasar a condiciones foto-autotróficas.

Finalmente, hemos cuantificado el contenido de esteviósido y rebaudiósido A en plantas de *S. rebaudiana* cv. Morita II, propagadas *in vitro* por tres métodos diferentes (medio semi-sólido; medio líquido y BIT). Encontramos un cambio notable en la abundancia relativa de esteviósido y rebaudiósido A en plantas cultivadas durante 21 días en BIT en comparación con los métodos de micropropagación semisólido y líquido (Fig. IV.2).

Se ha informado anteriormente que las condiciones ambientales en BIT® tienen una influencia crucial en el crecimiento de las plantas, la fisiología y el metabolismo del carbono en las hojas de plátano (Aragón et al. 2014), debido a la renovación continua de la atmósfera que rodea a las plántulas, lo que favorece la nutrición foto-autotrófica, crecimiento y producción de metabolitos especializados. En nuestro estudio, los BIT presentaron mejores resultados en cuanto a alargamiento de la planta, número de hojas y casi todos los rasgos morfológicos evaluados y también una mayor producción de SGs. Estos sistemas permiten un que el espacio entre los explantes y la parte superior del contenedor sea mayor en comparación con los otros métodos de cultivo evaluados, lo que facilita una mayor disponibilidad de gases y espacio para el alargamiento de los explantes, y así también promover una mayor actividad metabólica beneficiándose la producción de esteviósido y rebaudiósido A. Además, los sistemas de inmersión evaluados permitirán escalar y, por tanto, obtener un mayor número de plantas en comparación con el sistema convencional semisólido o líquido.

## VI. CONCLUSIONES GENERALES

1. Al comparar los niveles de transcripción de los genes estudiados (*SrKA13H*, *SrUGT74G1* y *SrUGT76G1*) entre cultivares, todos presentaron niveles más altos de expresión en el cultivar Morita II que en el cultivar Criolla. La producción de rebaudiósido A fue 9,69 veces mayor en el cultivar Morita II, que acumuló 3,4 veces menos esteviósido, que el cultivar Criolla.
2. Los niveles de transcripción de los genes *SrKA13H*, *SrUGT74G1* y *SrUGT76G1* en el cultivar Morita II, aumentaron a mayores intensidades lumínicas, favoreciendo la producción de esteviol glicósidos.
3. Se encontró que la mezcla de sustratos turba más zeolita favoreció todos los parámetros fisiológicos estudiados, así como la mayor producción de esteviósido y rebaudiósido A. Durante la transición de vitroplantas de condiciones mixo-tróficas (enraizamiento *in vitro*) a condiciones foto-autotróficas (aclimatación *ex vitro*), los niveles de transcripción génica de *SrKA13H*, *SrUGT74G1* y *SrUGT76G1* y la producción de diterpenos glicosilados aumentaron significativamente en plantas de *S. rebaudiana* (cv. Morita II).
4. Al comparar tres métodos de cultivo (medio semisólido, medio líquido y biorreactores de inmersión temporal) en términos de biomasa y producción de glucósidos de esteviol, se registraron los mayores indicadores de calidad morfológica y el mayor contenido de esteviol glicósidos en brotes cultivados en biorreactores de inmersión temporal, demostrándose que este sistema de cultivo *in vitro* es un método eficiente para la obtención de metabolitos especializados con alto poder edulcorante como el rebaudiósido A y el esteviósido.



## VII. REFERENCIAS GENERALES

- Acosta-Motos, J.R.; Noguera-Vera, L.; Barba-Espín, G.; Piqueras, A.; Hernández, J.A. (2019). Antioxidant Metabolism and Chlorophyll Fluorescence during the Acclimatisation to Ex Vitro Conditions of Micropropagated *Stevia rebaudiana* Bertoni Plants. *Antioxidants* 2019, 8, 615. <https://doi.org/10.3390/antiox8120615>
- Agarwal, G., Carcache, P.J.B., Addo, E.M., Kinghorn, A.D. (2020). Current status and contemporary approaches to the discovery of antitumor agents from higher plants. *Biotechnol. Adv.* 38, 107337. <https://doi.org/10.1016/j.biotechadv.2019.01.004>
- Ahmad, J., Khan, I., Blundell, R., Azzopardi, J., Mahomoodally, M.F. (2020). *Stevia rebaudiana* Bertoni.: An updated review of its health benefits, industrial applications and safety. *Trends Food Sci. Technol.*, 100, 177-189. <https://www.um.edu.mt/library/oar/handle/123456789/80705>
- Alamgir, A.N.M. (2017). Pharmacognostical Botany: Classification of Medicinal and Aromatic Plants (MAPs), Botanical Taxonomy, Morphology, and Anatomy of Drug Plants. *Prog. Drug Res.* 73, 177–293. <https://doi.org/10.1007/978-3-319-63862-16>
- Aman, N., Hadi, F., Khalil, S. A., Zamir, R., & Ahmad, N. (2013). Efficient regeneration for enhanced steviol glycosides production in *Stevia rebaudiana* (Bertoni). *Comptes Rendus Biologies*, 336(10), 486-492. <https://doi.org/10.1016/j.crv.2013.10.002>
- Anker, C.C.B., Rafiq, S., Jeppesen, P.B. (2019). Effect of Steviol Glycosides on Human Health with Emphasis on Type 2 Diabetic Biomarkers: A Systematic Review and Meta-Analysis of Randomized Controlled Trials. *Nutr.* 2019, Vol. 11, Page 1965 11, 1965. <https://doi.org/10.3390/NU11091965>
- Aragón, C., Gonzalez-Olmedo, J., Escalona, M. (2014). Comparison of plantain plantlets propagated in temporary immersion bioreactors and gelled medium during in vitro growth and acclimatization. *Biol. Plant.* 58, 29–38. <https://doi.org/10.1007/s10535-013-0381-6>
- Arigita, L., González, A., & Tamés, R. S. (2002). Influence of CO<sub>2</sub> and sucrose on photosynthesis and transpiration of *Actinidia deliciosa* explants cultured *in vitro*. *Physiol. Plant.*, 115 (1), 166-173. <https://doi.org/10.1034/j.1399-3054.2002.1150119.x>

- Ashour, M., Wink, M., Gershenzon, J. (2010). Biochemistry of Terpenoids: Monoterpenes, Sesquiterpenes and Diterpenes. *Biochem. Plant Second. Metab. Second Ed.* 40, 258–303. <https://doi.org/10.1002/9781444320503.CH5>
- Badjakov, I., Georgiev, V., Georgieva, M., Dincheva, I., Vrancheva, R., Ivanov, I., Georgiev, D., Hristova, D., Kondakova, V., Pavlov, A. (2021). Bioreactor technology for *in vitro* berry plant cultivation. *Plant Cell Tissue Differ. Second. Metab. Fundam. Appl.* 383–431. [https://doi.org/10.1007/978-3-030-30185-9\\_18](https://doi.org/10.1007/978-3-030-30185-9_18)
- Basharat, S., Huang, Z., Gong, M., Lv, X., Ahmed, A., Hussain, I., Li, J., Du, G., Liu, L. (2021). A review on current conventional and biotechnical approaches to enhance biosynthesis of steviol glycosides in *Stevia rebaudiana*. *Chinese J. Chem. Eng.* 30, 92–104. <https://doi.org/10.1016/j.cjche.2020.10.018>
- Bassard, J E., Møller, B.L., & Laursen, T. (2017). Assembly of dynamic P450-mediated metabolons-order versus chaos. *Curr. Mol. Biol. Rep.* 3 (1), 37-51. <https://doi.org/10.1007/s40610-017-0053-y>
- Bondarev, N.I., Sukhanova, M.A., Reshetnyak, O. V., Nosov, A.M. (2003). Steviol Glycoside Content in Different Organs of *Stevia rebaudiana* and Its Dynamics during Ontogeny. *Biol. Plant.* 2003 472 47, 261–264. <https://doi.org/10.1023/B:BIOP.0000022261.35259.4F>
- Brandle, J.E., Richman A., Swanson A.K., Chapman B.P. (2002). Leaf Ests from *Stevia rebaudiana*: a resource for gene discovery in diterpene synthesis. *Plant Mol Biol* 50(4–5):613–622. <https://doi.org/10.1023/a:1019993221986>
- Brandle, J.E., Telmer, P.G. (2007). Steviol glycoside biosynthesis. *Phytochemistry* 68(14):1855–1863. <https://doi.org/10.1016/j.phytochem.2007.02.010>
- Bridgen M.P., Van Houtven W., Eeckhaut T. (2018) Plant Tissue Culture Techniques for Breeding. In: Van Huylenbroeck J. (eds) *Ornamental Crops. Handbook of Plant Breeding*, vol 11. Springer, Cham. <https://doi.org/10.1007/978-3-319-90698-0>
- Cantabella, D., Piqueras, A., Acosta-Motos, J.R., Bernal-Vicente, A., Hernández, J.A., Díaz-Vivancos, P. (2017). Salt-tolerance mechanisms induced in *Stevia rebaudiana* Bertoni: Effects

- on mineral nutrition, antioxidative metabolism and steviol glycoside content. *Plant Physiol. Biochem.* 115, 484-496. <https://doi.org/10.1016/j.plaphy.2017.04.023>
- Carvalho, L.S.O., Ozudogru, E.A., Lambardi, M., Paiva, L. V. (2019). Temporary Immersion System for Micropropagation of Tree Species: a Bibliographic and Systematic Review. *Not. Bot. Horti Agrobot. Cluj-Napoca* 47, 269–277. <https://doi.org/10.15835/NBHA47111305>
- Castro, M.D.M., Demarco, D. (2008). Phenolic Compounds Produced by Secretory Structures in Plants: A Brief Review: 3, 12731284. <https://doi.org/10.1177/1934578X08000300809>
- Ceunen, S., Geuns, J.M.C. (2013). Steviol glycosides: chemical diversity, metabolism, and function. *J Nat Prod* 76(6): 1201–1228. <https://doi.org/10.1021/np400203>
- Chatsudthipong, V., Muanprasat, C., (2009). Stevioside and related compounds: Therapeutic benefits beyond sweetness. *Pharmacol. Ther.* 121, 41–54. <https://doi.org/10.1016/J.Pharmthera.2008.09.007>
- Christaki, E., Bonos, E., Giannenas, I., Karatzia, M.A., Florou-Paneri, P. (2013). *Stevia rebaudiana* as a novel source of food additives. *J. Food Nutr. Res.* 52, 195–202.
- Cornara, L., Bononi, M., Tateo, F., Serrato-Valenti, G., Mariotti, M.G. (2006). Trichomes on vegetative and reproductive organs of *Stevia rebaudiana* (Asteraceae). Structure and secretory products. 135, 25–37. <https://doi.org/10.1080/11263500112331350610>
- Cosson, P., Hastoy, C., Errazu, L.E., Budeguer, C.J., Boutié, P., Rolin, D., Schurdi-Levraud, V. (2019). Genetic diversity and population structure of the sweet leaf herb, *Stevia rebaudiana* B., cultivated and landraces germplasm assessed by EST-SSRs genotyping and steviol glycosides phenotyping. *BMC Plant Biol.* 19, 1–11. <https://doi.org/10.1186/S12870-019-2061>
- D'Amelia, V., Docimo, T., Crocoll, C., & Rigano, M. M. (2021). Specialized Metabolites and Valuable Molecules in Crop and Medicinal Plants: The Evolution of Their Use and Strategies for Their Production. *Genes*, 12(6), 936. <https://doi.org/10.3390/genes12060936>
- Darise, M., Kohda, H., Mizutani, K., Tanaka, O. (1983). Chemical Constituents of Flowers of *Stevia rebaudiana* Bertoni. *Agric. Biol. Chem.* 47, 133–135. <https://doi.org/10.1080/00021369.1983.10865596>

- De Vargas, W., Fortuna-Perez, A.P., Lewis, G.P., Piva, T.C., Vatanparast, M., Machado, S.R. (2019). Ultrastructure and secretion of glandular trichomes in species of subtribe *Cajaninae Benth* (Leguminosae, Phaseoleae). *Protoplasma* 256, 431–445. <https://doi.org/10.1007/S00709-018-1307-0>
- Dey, A., Kundu, S., Bandyopadhyay, A., Bhattacharjee, A. (2013). Efficient micropropagation and chlorocholine chloride induced stevioside production of *Stevia rebaudiana Bertoni*. *C. R. - Biol.*, 336 (1), 17–28. <https://doi.org/10.1016/j.crvi.2012.11.007>
- Dona, M., Mekhala Gunasena, K., Uththara, R.M., Senarath, S., Thamara, W., Sandun, P., Senarath, K. (2021). A Review on Chemical Composition, Biosynthesis of Steviol Glycosides, Application, Cultivation, and Phytochemical Screening of *Stevia rebaudiana* (Bert.) Bertoni. *J. Pharm. Res. Int.* 33, 85–104. <https://doi.org/10.9734/JPRI/2021/V33I29B31593>
- Ducos, J.-P., Lambot, C., Pétiard, V. (2007). Bioreactors for coffee mass propagation by somatic embryogenesis. *Int. J. plant Dev. Biol.* 1, 1–12.
- Ebrecht, A.C., van der Bergh, N., Harrison, S.T., Smit, M.S., Sewell, B.T., Opperman, D.J. (2019). Biochemical and structural insights into the cytochrome P450 reductase from *Candida tropicalis*. *Sci. Rep.* 9 (1), 1-11. <https://doi.org/10.1038/s41598-019-56516-6>
- Erb, M., Kliebenstein, D.J. (2020). Plant Secondary Metabolites as Defenses, Regulators, and Primary Metabolites: The Blurred Functional Trichotomy. *Plant Physiol.* 184, 39–52. <https://doi.org/10.1104/pp.20.00433>
- Escalona, M., Samson, G., Borroto, C., Desjardins, Y. (2003). Physiology of effects of temporary immersion bioreactors on micropropagated pineapple plantlets. *Vitr. Cell. Dev. Biol. - Plant* 31, 651–656. <https://doi.org/10.1079/IVP2003473>
- Espinosa-Leal, C.A., Puente-Garza, C.A. y García-Lara, S. 2018. *In vitro* plant tissue culture: means for production of biological active compounds. *Planta*, 248 (1): 1-18. <https://doi.org/10.1007/s00425-018-2910-1>
- Fila, G., Badeck, F. W., Meyer, S., Cerovic, Z., Ghashghaie, J. (2006). Relationships between leaf conductance to CO<sub>2</sub> diffusion and photosynthesis in micropropagated grapevine plants, before

- and after ex vitro acclimatization. J. Exp. Bot., 57 (11), 2687-2695. <https://doi.org/10.1093/jxb/er040>
- Gago, D., Vilavert, S., Bernal, M.Á., Sánchez, C., Aldrey, A., Vidal, N. (2021). The effect of sucrose supplementation on the micropropagation of *Salix viminalis* L. shoots in semisolid medium and Temporary Immersion Bioreactors. Forests 12 (10), 1408. <https://doi.org/10.3390/f12101408>
- Gantait, S., Das, A., Banerjee, J. (2018). Geographical Distribution, Botanical Description and Self-Incompatibility Mechanism of Genus Stevia. Sugar Tech 20, 1–10. <https://doi.org/10.1007/S12355-017-0563-1>
- Gardana, C., & Simonetti, P. (2018). Determination of steviol glycosides in commercial extracts of *Stevia rebaudiana* and sweeteners by ultra-high performance liquid chromatography Orbitrap mass spectrometry. Journal of Chromatography A, 1578, 8-14. <https://doi.org/10.1016/j.chroma.2018.09.057>.
- Geuns, J.M.C., Augustijns, P., Mols, R., Buyse, J.G., Driessen, B. (2003). Metabolism of stevioside in pigs and intestinal absorption characteristics of stevioside, rebaudioside A and steviol. Food Chem. Toxicol. 41, 1599–1607. [https://doi.org/10.1016/S0278-6915\(03\)00191](https://doi.org/10.1016/S0278-6915(03)00191)
- Georgiev, V., Schumann, A., Pavlov, A., Bley, T. (2014). Temporary immersion systems in plant biotechnology. Eng. Life Sci., 14 (6), 607-621. <https://doi.org/10.1002/elsc.201300166>
- Gold, N.D., Fossati, E., Hansen, C.C., DiFalco, M., Douchin, V., Martin, V.J. (2018). A combinatorial approach to study cytochrome P450 enzymes for de novo production of steviol glucosides in baker's yeast. ACS Synth. Biol. 7 (12):2918-2929. <https://doi.org/10.1021/acssynbio.8b00470>
- González, E.J. (2005). Mass propagation of tropical crops in temporary immersion systems. In: Hvoslef-Eide A.K., Preil W. (eds) Liquid Culture Systems for *in vitro* Plant Propagation. Springer, Dordrecht., 197–211. [https://doi.org/10.1007/1-4020-3200-5\\_12](https://doi.org/10.1007/1-4020-3200-5_12)
- Goyal, S. K., Samsher, & Goyal, R. K. (2010). Stevia (*Stevia rebaudiana*) a bio-sweetener: a review. International journal of food sciences and nutrition, 61 (1), 1-10. <https://doi.org/10.3109/09637480903193049>

- Goettemoeller, J., & Ching, A. (1999). Seed germination in *Stevia rebaudiana*. Perspectives on new crops and new uses. ASHS Press, Alexandria, VA, 510-511.
- Guengerich, F.P. (2018). Mechanisms of cytochrome P450-catalyzed oxidations. ACS catalysis, 8 (12), 10964-10976. <https://doi.org/10.1021/acscatal.8b03401>
- Gunaseena, M., Senarath, W.T. (2019). *In vitro* plant regeneration of *Stevia rebaudiana* through indirect organogenesis Int. J. Botany Stud. 4 (4), 199–203. [ISSN: 2455-541X](https://doi.org/10.2455-541X)
- Hajihashemi, S., Noedoost, F., Geuns, J., Djalovic, I., Siddique, K.H. (2018). Effect of cold stress on photosynthetic traits, carbohydrates, morphology, and anatomy in nine cultivars of *Stevia rebaudiana*. Front. Plant Sci. 9, 1430. <https://doi.org/10.3389/fpls.2018.01430>
- Haisel, D., Semorádová, S., Pospíšilová, J., & Synková, H. (2004). Acclimation of Plantlets to Ex Vitro Conditions: Effects of Air Humidity, Irradiance, CO<sub>2</sub> Concentration and Abscisic Acid (a Review). In II International Symposium on Acclimatization and Establishment of Micropropagated Plants 748, 29-38. <https://doi.org/10.17660/ActaHortic.2007.748.2>
- Harismah, K., Mirzaei, M., & Fuadi, A. M. (2018). *Stevia rebaudiana* in food and beverage applications and its potential antioxidant and antidiabetic: Mini review. J Comput Theor Nanosci. 24 (12), 9133-9137. <https://doi.org/10.1166/asl.2018.12110>, [24\(12\), 9133-9137.](https://doi.org/10.1166/asl.2018.12110)
- Hastoy, C., Cosson, P., Cavaignac, S., Boutié, P., Waffo-Tegu, P., Rolin, D., Schurdi-Levraud, V. (2019). Deciphering performances of fifteen genotypes of *Stevia rebaudiana* in southwestern France through dry biomass and steviol glycoside evaluation. Ind. Crops Prod. 128, 607–619. <https://doi.org/10.1016/J.INDCROP.2018.09.053>
- He, H., Bian, G., Herbst-Gervasoni, C.J., Mori, T., Shinsky, S.A., Hou, A., Mu, X., Huang, M., Cheng, S., Deng, Z., Christianson, D.W., Abe, I., Liu, T. (2020). Discovery of the cryptic function of terpene cyclases as aromatic prenyltransferases. Nat. Commun. 2020 111 11, 1–13. <https://doi.org/10.1038/s41467-020-17642-2>
- Hussain, A., Qarshi, I. A., Nazir, H., & Ullah, I. (2012). Plant tissue culture: current status and opportunities. Recent advances in plant *in vitro* culture, 1-28. <http://dx.doi.org/10.5772/50568>

- Ismail, T., Ponya, Z., Mushtaq, A., Masood, A. (2020). Stevia a bio sweetener scope in the European Union as a commercial product. m. -Eurasian J. Sustain. Agric. 14 (2), 23–27. <https://doi.org/10.22587/aejsa.2020.14.2.3>
- Jacques, S. (2016). Generation and screening of natural product-like compounds for antibiotic discovery. Memoria de Tesis presentada a la Facultad de Medicina para optar por el grado de Master en Ciencias en Biología Molecular. Universidad de Montreal.
- Jahangir Chughtai, M. F., Pasha, I., Zahoor, T., Khaliq, A., Ahsan, S., Wu, Z., Tanweer, S. (2020). Nutritional and therapeutic perspectives of *Stevia rebaudiana* as emerging sweetener; a way forward for sweetener industry. CYTA-Journal of Food, 18 (1), 164-177. <https://doi.org/10.1080/19476337.2020.1721562>
- Jain, C., Khatana, S., & Vijayvergia, R. (2019). Bioactivity of secondary metabolites of various plants: a review. International J. Pharm. Sci. Res., 10 (2), 494-498. [https://doi.org/10.13040/IJPSR.0975-8232.10\(2\).494-04](https://doi.org/10.13040/IJPSR.0975-8232.10(2).494-04)
- Jitendra, M., Monika, S., Ratan, S. D., Priyanka, G., Priyanka, S., Kiran, D. J. (2012). Micropropagation of an Anti diabetic Plant-*Stevia rebaudiana* Bertoni, (Natural Sweetener) in Hadoti Region of South-East Rajasthan, India. Int. J. Biol. Sci., 1 (3), 37-42. <http://www.isca.in/IJBS/Archive/v1i3/>
- Kang, H.J., Lee, H.N., Hong, S.J., Park, B.R., Ameer, K., Cho, J.Y., Kim, Y.M. (2022). Synthesis and characteristics of a rebaudioside-A like compound as a potential non-caloric natural sweetener by *Leuconostoc kimchii* dextransucrase. Food Chem. 366, 130623. <https://doi.org/10.1016/J.FOODCHEM.2021.130623>
- Khiraoui, A., Hasib, A., Faiz, C. A., Amchra, F., Bakha, M., & Boulli, A. (2017). *Stevia rebaudiana* Bertoni (Honey Leaf): A magnificent natural bio-sweetener, biochemical composition, nutritional and therapeutic values. J. Nat. Sci. Res, 7, 75-85. [ISSN 2225-0921](https://doi.org/10.2225/0921)
- Kim M.J., Jin J., Zheng J., Wong L., Chua N.H., Jang I.C. (2015). Comparative Transcriptomics Unravel Biochemical Specialization of Leaf Tissues of *Stevia* for Diterpenoid Production. Plant Physiol. 169(4): 2462-2466. <https://doi.org/10.1104/pp.15.01353>

- Kinghorn, A. D., Soejarto, D. D., Nanayakkara, N. P. D., Compadre, C. M., Makapugay, H. C., Hovanec-Brown, J. M., ... & Kamath, S. K. (1984). A phytochemical screening procedure for sweet ent-kaurene glycosides in the genus *Stevia*. *Journal of natural products*, 47(3), 439-444. <https://doi.org/10.1021/np50033a007>
- Koeduka, T., Sugimoto, K., Matsui, K. (2020). Biosynthesis and Regulation of Vegetative Plant Volatiles. *Biol. Plant Volatiles* 165–182. <https://doi.org/10.1201/9780429455612-11>
- Kurze, E., Wüst, M., Liao, J., McGraphery, K., Hoffmann, T., Song, C., Schwab, W. (2021). Structure–function relationship of terpenoid glycosyltransferases from plants. *Nat. Prod. Rep.* DOI <https://doi.org/10.1039/D1NP00038A>
- Lai, C.-C., Lin, H.-M., Nalawade, S.M., Fang, W., Tsay, H.-S. (2005). Hyperhydricity in shoot cultures of *Scrophularia yoshimurae* can be effectively reduced by ventilation of culture vessels. *J. Plant Physiol.* 162, 355–361. <https://doi.org/10.1016/j.jplph.2004.07.015>
- Lee, S.G., Salomon, E., Yu, O., Jez, J.M. (2019). Molecular basis for branched steviol glucoside biosynthesis. *PNAS.* 116 (26):13131-13136. <https://doi.org/10.1073/pnas.1902104116>
- Li, Y., Zhu, W., Cai, J., Liu, W., Akihisa, T., Li, W., Kikuchi, T., Xu, J., Feng, F., Zhang, J. (2021). The role of metabolites of steviol glycosides and their glucosylated derivatives against diabetes-related metabolic disorders. *Food Funct.* 12, 8248–8259. <https://doi.org/10.1039/D1FO01370J>
- Libik-Konieczny, M., Capecka, E., Tuleja, M., Konieczny, R. (2021). Synthesis and production of steviol glycosides: recent research trends and perspectives. *Appl. Microbiol. Biotechnol.* 105, 3883–3900. <https://doi.org/10.1007/S00253-021-11306-X>
- Lone, S. M., Hussain, K., Malik, A., Magray, M., Hussain, S. M., Rashid, M., & Farwah, S. (2020). Plant Propagation through Tissue Culture—A Biotechnological Intervention. *Int. J. Curr. Microbiol. App. Sci*, 9 (7), 2176-2190. <https://doi.org/10.20546/ijcmas.2020.907.254>
- Lucho, S.R., do Amaral, M.N., Benitez, L.C., Milech, C., Kleinowski, A.M., Bianchi, V.J., Braga, E.J.B. (2018). Validation of reference genes for RT-qPCR studies in *Stevia rebaudiana* in response to elicitor agents. *Physiol. Mol. Biol. Plants* 24, 767–779. <https://doi.org/10.1007/S12298-018-0583-7>



- Lucho, S.R., do Amaral, M.N., Milech, C., Bianchi, V.J., Almagro, L., Ferrer, M.Á., Calderón, A.A., Braga, E.J.B. (2021). Gibberellin reverses the negative effect of paclobutrazol but not of chlorocholine chloride on the expression of SGs/GAs biosynthesis-related genes and increases the levels of relevant metabolites in *Stevia rebaudiana*. *Plant Cell. Tissue Organ Cult.* 146, 171–184. <https://doi.org/10.1007/S11240-021-02059-6>
- Lyu, X., Lee, J., Chen, W.N. (2019). Potential Natural Food Preservatives and Their Sustainable Production in Yeast: Terpenoids and Polyphenols. *J. Agric. Food Chem.* 67, 4397–4417. <https://doi.org/10.1021/ACS.JAFC.8B07141>
- Madan, S., Ahmad, S., Singh, G.N., Kohli, K., Kumar, Y., Singh, R., Garg, M. (2010). *Stevia rebaudiana* (Bert.) Bertoni- A Review. *IJNPR Vol.1(3)*, 267–286.
- Mafu, S., Jia, M., Zi, J., Morrone, D., Wu, Y., Xu, M., Hillwig, M.L., Peters, R.J. (2016). Probing the promiscuity of ent-kaurene oxidases via combinatorial biosynthesis. *Proc. Natl. Acad. Sci. U. S. A.* 113, 2526–2531. <https://doi.org/10.1073/PNAS.1512096113>
- Mathur, S., Bulchandani, N., Parihar, S., Shekhawat, G.S. (2017). Critical review on steviol glycosides: Pharmacological, toxicological and therapeutic aspects of high potency zero caloric sweetener. *Int. J. Pharmacol.* 13, 916–928. <https://doi.org/10.3923/IJP.2017.916.928>
- Monteiro, W.R., Castro, M.D.M., Mazzoni-Viveiros, S.C., Mahlberg, P.G. (2001). Desenvolvimento e alguns aspectos histoquímicos de tricomas glandulares decelulares bisseriados de *Stevia rebaudiana* (Bert.) Bert. -Asteraceae. *Brazilian J. Bot.* 24, 349–357. <https://doi.org/10.1590/S0100-84042001000300013>
- Nagegowda, D.A., Gupta, P. (2020). Advances in biosynthesis, regulation, and metabolic engineering of plant specialized terpenoids. *Plant Sci.* 294, 110457. <https://doi.org/10.1016/J.PLANTSCI.2020.110457>
- Oviedo-Pereira, D., Alvarenga, S., Evangelista, S., Sepúlveda, G., & Rodríguez-Monroy, M. (2015). Micropropagación de *Stevia rebaudiana* Bertoni, un cultivo promisorio para México. *BioTecnología*, 19 (2), 14-27.

- Pacifico, S., Piccolella, S., Nocera, P., Tranquillo, E., Dal Poggetto, F., Catauro, M. (2017). Steviol glycosides content in cultivated *Stevia rebaudiana* Bertoni: A new sweet expectation from the Campania region (Italy). *J. Food Compos. Anal.* 63, 111–120. <https://doi.org/10.1016/J.JFCA.2017.07.041>
- Pande, S.S., Gupta, P. (2013). Plant tissue culture of *Stevia rebaudiana* (Bertoni): A review. *J. Pharmacogn. Phyther.* 5, 26–33. <https://doi.org/10.5897/JPP13.0258>
- Parris, C.A., Shock, C.C., Qian, M. (2016). Dry Leaf and Steviol Glycoside Productivity of *Stevia rebaudiana* in the Western United States. *HortScience* 51, 1220–1227. <https://doi.org/10.21273/Hortsci11149-16>
- Patil, V. N., & Shahnawaz, M. (2021). Tissue Culture Approaches to Enhance Plant Secondary Metabolites Production. In: Shahnawaz, Mohd., editor. *Biotechnological Approaches to Enhance Plant Secondary Metabolites: Recent Trends and Future Prospects*, 89. <https://doi.org/10.1201/97810030034957>
- Peteliuk, V., Rybchuk, L., Bayliak, M., Storey, K.B., Lushchak, O. (2021). Natural sweetener *Stevia rebaudiana*. *EXCLI J.* 20, 1412–1430. <https://doi.org/10.17179/Excli2021-421>
- Pramastya, H., Song, Y., Elfahmi, E.Y., Sukrasno, S., Quax, W.J. (2020) Positioning *Bacillus subtilis* as terpenoid cell factory. *J Appl Microbiol.* 130, 1839-1856. <https://doi.org/10.1111/jam.14904>
- Pu, X., Dong, X., Li, Q., Chen, Z., Liu, L. (2021). An update on the function and regulation of MEP and MVA pathways and their evolutionary dynamics. *J Integr Plant Biol.* 63 (7), 1-16. <https://doi.org/10.1111/jipb.13076>
- Ramesh, K., Singh, V., Megeji, N.W. (2006). Cultivation of *Stevia* [*Stevia rebaudiana* (Bert.) Bertoni]: A Comprehensive Review. *Adv. Agron.* 89, 137–177. [https://doi.org/10.1016/S0065-2113\(05\)89003-0](https://doi.org/10.1016/S0065-2113(05)89003-0)
- Ramírez-Mosqueda. M.A., Iglesias-Andreu, L.G., Ramírez-Madero, G., Hernández-Rincón, E,U. (2016) Micropropagation of *Stevia rebaudiana* Bert. in temporary immersion systems and evaluation of genetic fidelity. *S. Afr. J. Bot.* 106: 238–243. <https://doi.org/10.1016/j.sajb.2016.07.015>

- Richman, A., Swanson, A., Humphrey, T., Chapman, R., McGarvey, B., Pocs, R., Brandle, J. (2005). Functional genomics uncovers three glucosyltransferases involved in the synthesis of the major sweet glucosides of *Stevia rebaudiana*. *Plant J.* 41(1): 56-67. <https://doi.org/10.1111/j.1365-313X.2004.02275.x>
- Salazar-Cerezo, S., Martínez-Montiel, N., García-Sánchez, J., Pérez-y-Terrón, R., & Martínez-Contreras, R. D. (2018). Gibberellin biosynthesis and metabolism: A convergent route for plants, fungi and bacteria. *Microbiol. Res.* 208, 85-98. <https://doi.org/10.1016/j.micres.2018.01.010>
- Scientific Committee on Food SCF. (1999). Opinion on *Stevia Rebaudiana* Bertoni Plants And Leaves. Bruselas, Bélgica. Citado el 20 de noviembre de 2021. Disponible en [http://www.europa.eu.int/comm/dg24/health/sc/scf/index\\_en.html](http://www.europa.eu.int/comm/dg24/health/sc/scf/index_en.html)
- Shahnawaz, Pandey, D.K., Konjengbam, M., Dwivedi, P., Kaur, P., Kumar, V., Ray, D., Ray, P., Nazir, R., Kaur, H., Parida, S., Dey, A. (2021). Biotechnological interventions of in vitro propagation and production of valuable secondary metabolites in *Stevia rebaudiana*. *Appl. Microbiol. Biotechnol.* 105(23): 8593-8614. <https://doi.org/10.1007/S00253-021-11580-9>
- Shahzad, A., Sharma, S., Parveen, S., Saeed, T., Shaheen, A., Akhtar, R., Yadav, V., Upadhyay, A., Ahmad, Z. (2017). Historical Perspective and Basic Principles of Plant Tissue Culture. In: Abdin M., Kiran U., Kamaluddin, Ali A. (eds). *Plant Biotechnology: Principles and Applications*. Springer, Singapore. pp 1-36. <https://doi.org/10.1007/978-981-10-2961-5>
- Shulgina, A.A., Kalashnikova, E.A., Tarakanov, I.G., Kirakosyan, R.N., Cherednichenko, M.Y., Polivanova, O.B., Baranova, E.N., Khaliluev, M.R. (2021). Influence of Light Conditions and Medium Composition on Morphophysiological Characteristics of *Stevia rebaudiana* Bertoni In Vitro and In Vivo. *Horticulturae* 2021, 7, 195. <https://doi.org/10.3390/horticulturae7070195>
- Singh, A., Singh, K., Singh, P., Singh, M. P. (2015). Medicinal prospective and floral biology of candy leaf (*Stevia rebaudiana* Bertoni). *Int J Adv Res.* 3 (9), 628-636. [ISSN 2320-5407](https://doi.org/10.17822/IJAR.V3I9.628-636)

- Smyth, S. J., Macall, D. M., Phillips, P. W., de Beer, J. (2020). Implications of biological information digitization: Access and benefit sharing of plant genetic resources. *J. World Intell. Prop.* 23( 3-4), 267-287. <https://doi.org/10.1111/jwip.12151>
- So, G., Lee, S. R., Kim, S. H., Ha, C. W., Park, Y., Jang, S., ... & Sohn, E. H. (2019). Antioxidant and antimelanogenic effects of *Stevia rebaudiana* flower extract. *Korean J. Plant Resour.* 32, 220-227. <https://doi.org/10.7732/KJPR.2019.32.3.220>
- Soejarto, D.D., Addo, E.M., Kinghorn, A.D. (2019). Highly sweet compounds of plant origin: From ethnobotanical observations to wide utilization. *J. Ethnopharmacol.* 243, 112056. <https://doi.org/10.1016/J.JEP.2019.112056>
- Soufi, S., D'Urso, G., Pizza, C., Rezgui, S., Bettaieb, T., Montoro, P. (2016). Steviol glycosides targeted analysis in leaves of *Stevia rebaudiana* (Bertoni) from plants cultivated under chilling stress conditions. *Food Chem.*, 190, 572-580. <https://doi.org/10.1016/j.foodchem.2015.05.116>
- Srinath, M., Shailaja, A., Bindu, B.B.V., Giri, C.C. (2021). Molecular Cloning and Differential Gene Expression Analysis of 1-Deoxy-D-xylulose 5-Phosphate Synthase (DXS) in *Andrographis paniculata* (Burm. f) Nees. *Mol. Biotechnol.* 63, 109–124. <https://doi.org/10.1007/S12033-020-00287-3/>
- Steinmacher, D.A., Guerra, M.P., Saare-Surminski, K., Lieberei, R. (2011). A temporary immersion system improves *in vitro* regeneration of peach palm through secondary somatic embryogenesis. *Ann. Bot.* 108 (8), 1463–1475. <https://doi.org/10.1093/aob/mcr033>
- Supaibulwattana, K., Kuntawunginn, W., Cha-um, S., Kirdmanee, C. (2011). Artemisinin Accumulation and Enhanced Net Photosynthetic Rate in Qinghao (*Artemisia annua* L.) Hardened *in vitro* in Enriched-CO<sub>2</sub> Photoautotrophic Conditions. *Plant Omics* 4 (2), 75–81. <https://search.informit.org/doi/10.3316/informit.873514673732775>
- Suttipanta, N., Pattanaik, S., Kulshrestha, M., Patra, B., Singh, S. K., & Yuan, L. (2011). The transcription factor CrWRKY1 positively regulates the terpenoid indole alkaloid biosynthesis in *Catharanthus roseus*. *Plant Physiol.* 157 (4), 2081-2093. <https://doi.org/10.1104/pp.111.181834>

- Tanaka, T., Kohda, H., Tanaka, O., Chen, F. H., Chou, W. H., & Leu, J. L. (1981). Rubusoside ( $\beta$ -D-glucosyl ester of 13-O- $\beta$ -D-glucosyl-steviol), a sweet principle of *Rubus chingii* Hu (Rosaceae). *Agr Biol Chem.* 45 (9), 2165-2166. <https://doi.org/10.1080/00021369.1981.10864857>
- Tavakoli, H., Tavakoli, N., & Moradi, F. (2019). The effect of the elicitors on the steviol glycosides biosynthesis pathway in *Stevia rebaudiana*. *Funct. Plant Biol.* 46 (9), 787-795. <https://doi.org/10.1071/FP19014>
- Vázquez-Baxcajay, L., Robledo-Paz, A., Muratalla-Lúa, A., & Conde-Martínez, V. (2014). Micropropagación de *Stevia rebaudiana* Bertoni y detección de steviósidos. *Bioagro*, 26(1), 49-56. ISSN 1316-336
- Wambugu, P.W., Ndjiondjop, M.N., Henry, R.J. (2018). Role of genomics in promoting the utilization of plant genetic resources in genebanks. *Brief. Funct. Genom.* 17 (3), 198-206, <https://doi.org/10.1093/bfpg/ely014>
- Weckx, S., Inzé, D., Maene, L. (2019). Tissue culture of oil palm: finding the balance between mass propagation and somaclonal variation. *Front. Plant Sci.* 10, 722. <https://doi.org/10.3389/fpls.2019.00722>
- Werck-Reichhart, D., & Feyereisen, R. (2000). Cytochromes P450: a success story. *Genome Biol.* 1 (6), 1-9. <https://doi.org/10.1186/gb-2000-1-6-reviews3003>
- Werker, E. (2000). Trichome diversity and development. *Adv. Bot. Res.* 31, 261–283. [https://doi.org/10.1016/S0065-2296\(00\)31005-9](https://doi.org/10.1016/S0065-2296(00)31005-9)
- Wölwer-Rieck, U., May, B., Lankes, C., Wüst, M. (2014). Methylerythritol and mevalonate pathway contributions to biosynthesis of mono-, sesqui-, and diterpenes in glandular trichomes and leaves of *Stevia rebaudiana* Bertoni. *J. Agric. Food Chem.* 62, 2428–2435. <https://doi.org/10.1021/JF500270S/>
- Xu, X., Yuan, H., Yu, X., Huang, S., Sun, Y., Zhang, T., Liu, Q., Tong, H., Zhang, Y., Wang, Y. (2021). The chromosome-level *Stevia* genome provides insights into steviol glycoside biosynthesis. *Hortic. Res.* 8 (1):1-10. <https://doi.org/10.1038/s41438-021-00565-4>

- Yadav, A.K., Singh, S., Dhyani, D., Ahuja, P.S. (2011). A review on the improvement of stevia [*Stevia rebaudiana* (Bertoni)]. *Can. J. Plant Sci.* 91, 1–27. <https://doi.org/10.4141/CJPS10086>
- Yoneda, Y., Nakashima, H., Miyasaka, J., Ohdoi, K., Shimizu, H. (2017<sup>a</sup>). Impact of blue, red, and far-red light treatments on gene expression and steviol glycoside accumulation in *Stevia rebaudiana*. *Phytochemistry* 137:57-65. <https://doi.org/10.1016/j.phytochem.2017.02.002>
- Yoneda, Y., Shimizu, H., Nakashima, H., Miyasaka, J., Ohdoi, K. (2017<sup>b</sup>). Effects of light intensity and photoperiod on improving steviol glycosides content in *Stevia rebaudiana* (Bertoni) Bertoni while conserving light energy consumption. *J. Appl. Res. Med. Aromat. Plants* 7: 64-73. <https://doi.org/10.1016/j.jarmap.2017.06.001>
- Zaidan, U.H., Hamid, S.N., Mat Yusof, M.F., Ahmad, S. Abd Ghani, S.S., Shamsi, S. (2018). Chemical evaluation and Antioxidant Properties of Extracts and Essential Oil from *Stevia Rebaudiana* Leaves. *Malaysian Appl. Biol.* 47 (2), 15–23. <https://jms.mabjournal.com/index.php/mab/article/view/1941>
- Zhang, C., Hong, K. (2020). Production of terpenoids by synthetic biology approaches. *Front. Bioeng. Biotechnol.* 8: 347. <https://doi.org/10.3389/fbioe.2020.00347>
- Zhou, X. L., Liang, C. Q., Xu, Q., Zhang, X. Y., Liang, X. F., Huang, Q. Y., & Su, X. J. (2012). Study on chemical constituents of *Angelica keiskei*. *Chin. J. Exp. Trad. Med. Form.* 18, 103-105.
- Zhou, X., Gong, M., Lv, X., Liu, Y., Li, J., Du, G., Liu, L. (2021). Metabolic engineering for the synthesis of steviol glycosides: current status and future prospects. *Appl. Microbiol. Biotechnol.* 1-15. <https://doi.org/10.1007/s00253-021-11419-3>